

Auxiliary Communications Field Operations Guide (AUXFOG)

**US Department of Homeland Security
Office of Emergency Communications
Version 1.0**



Homeland Security

November 2013

DEFINITION: “Interoperability: The ability of emergency responders to communicate among jurisdictions, disciplines, and levels of government, using a variety of frequency bands, as needed and as authorized.”¹

¹ National Emergency Communications Plan, July 2008, Rev. Aug 7, 2008, pg. 2.

Introduction

The Auxiliary Communications Field Operations Guide (AUXFOG) is a collection of technical reference and training information to aid trained volunteer Auxiliary Communications (AuxComm) personnel, and the agencies they serve, to supplement local emergency communications when AuxComm support is requested.

AuxComm is an all-inclusive term used to describe the many organizations and personnel that provide various types of communications support to emergency management, public safety, and other government agencies.

Auxiliary Communicators have been assisting the public safety community for over 100 years. These uniquely qualified communicators give their time and resources freely, without hesitation, providing auxiliary communications to NIMS/ICS personnel and public safety partners. Additionally, Auxiliary Communicators frequently provide communications support during planned events, community functions, and training exercises.

The contents of this guide are for training and reference, and should support the goals of your local, county, region or state government officials. It should not be used in any way to circumvent or override those established goals. Direction for the use of auxiliary communications, under NIMS/ICS, will come from either a Communications Leader (COML) or a member of the public safety agency being supported.

Auxiliary Communications (AuxComm) covers a broad range of systems that could potentially be used during an incident to include: High Frequency (HF), Very High Frequency (VHF), Ultra High Frequency (UHF), satellite communications (SATCOM), microwave, Wi-Fi, digital, video, photos, Voice over Internet Protocol (VoIP), and other modes.

Trained Auxiliary Communicators are a valuable communications resource tool that can be used by local, county, regional, tribal or state agencies/organizations. We hope you will find this document a useful guide as you provide communications support to these various groups. To download copies of the AUXFOG, please visit www.publicsafetytools.info. Please send comments, updates, suggestions, or corrections regarding the AUXFOG to the following point of contact:

John E. Peterson
DHS/Office of Emergency Communications
Telecommunications Specialist
comu@hq.dhs.gov

About this Guide

The purpose of the Auxiliary Communications Field Operations Guide (AUXFOG) is to increase efficiency in establishing communications during incidents, create a consistent knowledge base of communications channels and networks, and provide a helpful tool for pre-planning and communications training and exercises.

This AUXFOG is the property of:

Name:

Primary Contact Phone:

Alternate Contact Phone:

E-Mail:

Call Sign:

Other

Users adding information to this AUXFOG (e.g., telephone numbers for government officials, or other potentially sensitive information) should review their state's public records requirements. If the nature of information added to the AUXFOG changes the handling instructions or sensitivity level of the document (such as "For Official Use Only"), then the appropriate classification should be added prior to printing or publishing.

Table of Contents

INTRODUCTION	III
RECORD OF CHANGE	IV
ABOUT THIS GUIDE.....	V
TABLE OF CONTENTS	VII
TABLE OF FIGURES	IX
1 SAFETY	1-1
1.1 Family Safety	1-1
1.2 Personal Safety	1-1
1.3 Situational Awareness	1-2
1.4 Local hazards.....	1-2
1.5 Power Safety	1-2
1.6 RF Safety	1-2
1.7 Equipment Safety	1-2
2 AUXILIARY COMMUNICATIONS	2-1
2.1 Radio Service Rules and Regulations	2-1
3 DEPLOYMENT, MOBILIZATION, AND DEMOBILIZATION	3-1
3.1 Definitions	3-1
3.2 Activation Etiquette.....	3-1
3.3 Pre-deployment.....	3-3
3.3.1 Go Kit	3-3
3.4 Mobilization	3-4
3.5 Deployment	3-4
3.6 Demobilization.....	3-5
Appendix A Auxiliary Communications (AuxComm) Point of Contact (POC) Information.....	A-1
A.1 AuxComm Contact List.....	A-1
A.2 Communications Unit Contact List.....	A-2
A.3 Local EMA Contact List	A-3
A.4 State EMA Contact List	A-4
Appendix B Telephone Network Communications	B-1
B.1 Priority Services	B-1
B.1.1 Government Emergency Telecommunications Service (GETS)	B-1
B.1.2 Wireless Priority Service (WPS)	B-1
B.2 Text Messaging	B-2
B.3 NOAA Weather Radio “All Hazards” Broadcasts	B-5

B.4 Standard Time and Frequency Broadcasts	B-6
Appendix C US Amateur Radio Band Plan	C-1
C.1 Band Recommendations Based on Time of Day	C-7
C.2 Amateur Radio Frequencies	C-7
C.2.1 VHF Amateur Radio Frequencies	C-8
C.2.2 UHF Amateur Radio Frequencies	C-11
C.2.3 HF Amateur Radio Frequencies	C-12
C.2.4 GMRS, MURS, FRS, Industrial/Business, etc.	C-14
C.3 Other Reference Frequencies	C-15
C.3.1 VHF Low Band	C-15
C.3.2 VHF High Band	C-16
C.3.3 UHF Band	C-17
C.3.4 700 MHz Band (Digital Use Only)	C-18
C.3.5 800 MHz Band	C-21
C.3.6 NOAA All-Hazards Alert Radio – Event Codes	C-22
C.3.7 Aviation Frequencies (AM)	C-25
C.3.8 Marine Frequencies	C-26
C.3.9 MULTI-USE RADIO SERVICE (MURS)	C-32
C.3.10 Citizens Band (CB) Frequencies	C-32
C.3.11 Common Business Frequency Table	C-33
C.3.12 Railroad Frequencies	C-34
C.3.13 Search and Rescue (SAR) Frequencies	C-35
C.3.14 Emergency Support Functions	C-36
Appendix D Field Expedient Antennas	D-1
D.1 Field Expedient Antennas	D-1
D.1.1 Ground Plane Antennas (VHF/UHF)	D-1
D.1.2 Coaxial Sleeve Antennas (VHF)	D-4
D.1.3 Dipole Antennas (HF)	D-6
D.2 Emergency Center of Activity Frequencies for Amateur Radio	D-8
Appendix E Connectors	E-1
E.1 RJ-45 Wiring	E-1
E.2 RS-232 Connectors (DB9 and DB25)	E-2
E.3 RF Connectors	E-3
Appendix F Cable Properties	F-1
Appendix G Coded Squelch Systems	G-1
G.1 Continuous Tone Coded Squelch System (CTCSS) Tones and Codes	G-1
G.2 Digital Coded Squelch (DCS) Codes	G-3
G.3 Network Access Codes (NAC)	G-4
Appendix H GMRS/FRS	H-1
H.1 General Mobile Radio Service (GMRS)	H-1

H.1.1 Licensing.....	H-1
H.1.2 Channels.....	H-2
Appendix I Incident Command System (ICS).....	I-1
I.1 Basic ICS Organization	I-1
I.1.1 ICS Organizational Chart	I-1
I.1.2 Incident Command System – Basic Organization.....	I-3
I.1.3 Expanded ICS Organization.....	I-4
I.1.4 Logistics Section Communications Unit.....	I-5
I.1.5 Communications Unit Organizational Structure	I-6
I.1.6 ICS Position Titles.....	I-7
I.2 Communications Unit Position Descriptions	I-8
I.2.1 Auxiliary Communications	I-8
I.2.2 Communications Unit Leader (COML).....	I-8
I.2.3 Incident Communications Center Manager (INCM)	I-8
I.2.4 Radio Operator (RADO).....	I-8
I.2.5 Incident Communications Technician (COMT)	I-8
I.2.6 Technical Specialist (THSP).....	I-9
I.3 External Support to the Communications Unit	I-9
I.3.1 Communications Coordinator (COMC).....	I-9
I.4 ICS Roles and Responsibilities.....	I-10
I.5 ICS Forms	I-12
I.5.1 ICS Form 205.....	I-14
I.5.2 ICS Form 205A	I-15
I.5.3 ICS Form 213.....	I-16
I.5.4 ICS Form 214.....	I-17
I.5.5 ICS Form 217A	I-18
Appendix J Standard Phonetic Alphabet and its Equivalentents	J-1
Appendix K AUXFOG URL/Website Listing	K-1
Appendix L Glossary and Terms	L-1

Table of Figures

Figure 1. VHF and UHF Ground Plane Design.....	D-2
Figure 2. Example of VHF Ground Plane Antenna	D-3
Figure 3. Coaxial Sleeve Antenna Design	D-4
Figure 4. Example of VHF Coaxial Sleeve Antenna	D-5

1 Safety

1.1 Family Safety

Your number one concern in safety is the protection of you, your family and your property. Taking action on this just after being activated is too late. Depending on the nature of the incident or your deployment schedule, you may be required to respond directly to your assignment and not have an opportunity to go home first. You need to plan for your family and property's safety **now**, before an event occurs. A basic checklist of items is listed below, but you should add additional items based on your personal circumstances:

- Does your entire family have at least three days of non-refrigerated food and bottled water to sustain them?
- Do you have a medical kit that is easily accessible to your family?
- Do you have fully functioning fire extinguishers in the house?
- Does your family have a method of escape out of the immediate area?
- Does your family have maps indicating their primary and alternate escape routes?
- Does your family have an alternate place to go if necessary? This may be another family member's house or a designated meeting point. Are alternate phone numbers written down and in your wallet/purse? (Note: cell phones/texting and regular phones may be down. Do you have an alternate way of communicating?)
- Designate a family member or other person outside the affected area to serve as the primary point of contact for all family members to call. Consider using the Red Cross "Safe and Well" resource located at www.redcross.org/safeandwell
- Do you have copies of your valuable documents packaged and ready to quickly take with you? Items such as marriage license, mortgage paperwork, deeds, insurance paperwork, any wills, a listing of bank and credit card contacts along with account numbers?
- Do you have access to additional cash? ATMs will likely be down, and banks closed, during a major event.
- Do you have sufficient fuel?

1.2 Personal Safety

Upon arrival at your assigned deployment location, go to the designated check-in point and report to the COML, EOC Manager, or other point of contact. If deploying as a single resource, identify the Safety Officer or Medical Unit Leader, and obtain location of emergency medical support resources. If deploying as part of a team, ask your leader for details on emergency medical support. Also consider these items:

- Prepare for health issues
- Have sufficient supply of medications
- Environmental concerns
- Best routes for access, departure, or rapid evacuation/escape to/from your deployment location
- Bring plenty of water and drink it
- Fatigue leads to inattention and accidents. Take short breaks
- If Fire/EMS are on-scene, note their locations

Include your medications in your "Go Kit" along with a list of your medical conditions and required medications. Make your Team Leader/Safety Officer aware of these along with any limitations in the ability to carry out assignments.

1.3 Situational Awareness

- Be sure that you know exactly where you are going for your assignment.
- If you are going to an unfamiliar site, be sure you can locate it on your map, GPS, or other resource prior to departure. Field operations often occur at sites with esoteric names that do not appear on a map.
- During a deployment, if you encounter a problem or emergency situation, it may be necessary to request assistance from public safety via your radio network. Know where you are located.
- Locate exits and escape routes and mark them.

1.4 Local hazards

- Survey the local area
- Locate any existing power or overhead wires
- Identify potential hazardous materials (HAZMAT)
- Wildlife (snakes, scorpions, etc.)
- Make sure wires/cables are secured/taped-down either underfoot or above 8 ft. elevation, use flagging/caution tape or cones to clearly mark hazards
- Guy wires marked with tape and glow-sticks
- Look for trip and fall hazards
- Ad-hoc power distribution.
- Water hazards
- Vehicle traffic

1.5 Power Safety

- Inspect everything
- Isolate/mark generators and power sources with hazard tape
- Use GFI protected circuits
- Verify safety ground connections
- Check/test before you touch or attach anything
- Verify every connection before you energize the circuit

1.6 RF Safety

- HF – Antenna should be at least 50 feet away from humans and radio equipment. More separation may be required to reduce Radio Frequency Interference (RFI)
- Use minimum necessary RF power for effective communications
- Keep antenna elements away from personnel and elevated beyond finger/touch range
- Mark/flag antennas and feedlines

1.7 Equipment Safety

- Generators should always be used outside, in well-ventilated areas away from all doors, windows, and vent openings
- Locate fuel away from personnel, tents/buildings and vehicles
- Place fire extinguisher at a location between the area of operations and the primary power source
- DO NOT refuel a running or hot generator
- Have a second person standing-by during refueling operations
- Route all power cables/cords safely and away from pathways, identify with visible markers, flags, etc.
- DO NOT locate antennas near overhead wires
- When installing HF antennas watch for people, animals, vehicles

- If using ballistic means (slingshot, bow, compressed air gun, etc.) for installing HF antennas, consider any hazards that you might create

2 Auxiliary Communications

2.1 Radio Service Rules and Regulations

Auxiliary communicators are required to obtain and maintain current licenses to operate on frequencies in the applicable radio services (e.g., Amateur Radio Service, Personal Radio Services, Private Land Mobile Radio Service, etc.). Auxiliary communicators must comply with the rules and regulations applicable to the specific radio service where they will be operating. An exception that allows operating outside of normal licensing requirements in cases of imminent threat to life or property is clearly defined in the rules and regulations.

Some forms of auxiliary communications require licensing from the FCC (or, for U.S. Government stations, authorization from the NTIA), others are licensed by rule, and some are unlicensed. Auxiliary communications personnel are expected to be familiar and comply with the applicable rules, regulations, and restrictions pertaining to the use of various forms of auxiliary communications.

This AUXFOG contains listings of frequencies used by several different radio service users and agencies. These listings are for reference purposes only. Prior to operating on any radio frequency, proper licensing and/or authorization must first be obtained. The FCC and NTIA documents described in this section contain all relevant rules, policies, and procedures for operating on any radio frequency

Rules and regulations can be found in the following documents:

1. Non-Federal Users:
 - a. Title 47 of the Code of Federal Regulations (CFR) which contains the Federal Communications Commission (FCC) rules and regulations
 - b. http://www.ecfr.gov/cgi-bin/text-idx?c=ecfr&tpl=/ecfrbrowse/Title47/47cfrv5_02.tpl
2. Federal Users:
 - a. National Telecommunications and Information Administration (NTIA) Manual of Regulations and Procedures for Federal Radio Frequency Management
 - b. http://www.ntia.doc.gov/files/ntia/publications/redbook/2012-05/Manual_2012.pdf

For reference purposes, the following parts of Title 47 CFR contain all rules and regulations for the listed radio services:

- Part 80: Maritime Services
- Part 87: Aviation Services
- Part 90: Private Land Mobile Radio Services
- Part 95: Personal Radio Services (includes GMRS, FRS, CB, and MURS)
- Part 97: Amateur Radio Service

Due to the size and extensive volume of information contained in these documents, the websites above are also provided for your reference in the appendices of this field operations guide. As an auxiliary communicator, it is your responsibility to become knowledgeable of these documents, and to adhere to the requirements they contain.

NOTES:

3 Deployment, Mobilization, and Demobilization

3.1 Definitions

Demobilization	The orderly, safe, and efficient return of an incident resource to its original location and status.
Deployment	To move strategically into a position ready for use.
Mobilization	The process and procedures used by all organizations (local, state, and federal) for activating, assembling, and transporting resources that have been requested to respond to or support an incident

3.2 Activation Etiquette

Over the years, emergency managers have sometimes been reluctant to use volunteers within their area of operations for a variety of reasons. It may stem from a situation that happened years, or maybe decades prior, and they haven't forgotten about it. It is important to be sensitive to the needs of the organizations and personnel you hope to support. It can take a very long time to develop an effective working relationship with emergency management or other public safety officials. The items below are listed in no particular order, and are provided to assist with relationship building efforts.

1. Activation and deployment of AuxComm resources must be requested and authorized by public safety, emergency management, or other government organizations. When activated, AuxComm personnel will be tasked with specific responsibilities provided through an established chain of command for the incident or event. This AUXFOG does not provide any form of direction or policy, but is solely intended to serve as resource guide that may be used for reference when executing assigned tasks
2. In a NIMS/ICS environment you may be asked to do things that have nothing to do with AuxComm. Since you will be part of the NIMS/ICS team, do what you are asked. Seek out other opportunities, via the COML, to assist in any way possible.
3. When you have told people that you, and/or, your group will support them in case of an emergency, be prepared to do just that. One missed event may give the impression that you were not really serious about your commitment.
4. Make sure your family is well prepared prior to your activation, which may not allow you to come home right away. **Your family is your first priority**, and needs to be taken care of prior to an event occurring.
5. Professional appearances are important. Before responding to your assigned location ensure that you know what the expected dress code or uniform (shirts, badges, vest, etc.) requirements are and ensure your attire falls within those guidelines when reporting for duty.
6. Never take your own personal equipment or tools into an EOC, or other emergency operations area without first receiving approval from the local manager of that area. Government agencies often have equipment and resources needed to perform the requested tasks and functions. Adding to or changing existing equipment configurations and installations can result in a multitude of complications. Mixing personal equipment with government owned equipment without proper authorization and accountability may lead to additional issues.
7. Before setting up any equipment or deciding on a workspace location, you must first find out exactly where the emergency manager or COML wants you to set up. The person responsible for the facilities and/or your tasking must coordinate among multiple

functions which are occurring in the same area, and there may be specific locations designated for certain functions.

8. Once activated, arrive at or shortly before the specified reporting time. By arriving too early, you may be in the way of setup or other operations that must be completed before you can safely and effectively work at that location. Arriving late may negatively impact the ability to effectively provide the requested support, and will damage future relationships or opportunities. If the assignment is for a pre-planned event, arrive early enough to complete the necessary equipment set up and testing. You must be ready to go at the designated start time. When the event is over or your shift has ended, do not leave until you are released, and have completed the specified demobilization process with your incident supervisor, COML, or other designee.
9. If there are any requirements, such as badges, ID or other verification type paperwork, needed to get into an area, make sure you coordinate with the COML or the emergency manager prior to the event to obtain the necessary access instructions and authorization.
10. Have a minimum three day supply of food, water, medications, sleeping needs and cash available to you either at the site you will be supporting or readily available to you, such as in your vehicle or other approved storage location. If you feel additional items are needed, make sure they are readily available to you as well.
11. Always have separate headphones / headsets readily accessible for every radio you will be responsible for operating. Without headphones, the noise level in an EOC, or other similar location, increases over time. If your radios are too loud, you may be asked to turn them down or off. Your radios are a low priority when normal communications are working, so take every step to be considerate of other personnel in the same room by using headphones to minimize unnecessary distraction to others.
12. As an Auxiliary Communications resource, your primary mission is to provide support to the COML or the Emergency Manager. These positions are in your supervisory chain of command for the incident or event. Failure to follow their direction may prevent you or your organization from being utilized in the future for emergency communications support.
13. AuxComm personnel are often viewed as general communications resources. AuxComm personnel may be asked to perform tasks or use equipment other than radios, e.g., assisting with telephone calls, monitoring scanners, serve as message runners, review various websites, enter/track data using emergency management software applications, or other information sources that are providing situational awareness data to an Emergency Manager.

Prior to activating for an event, make sure you have already taken care of your family with regard to planning, sufficient supplies, and alternate methods of contact should phones/internet fail. You may not have an opportunity to go home once an activation occurs.

3.3 Pre-deployment

Never self-deploy. Any deployment should be at the direction of an agency/organization of competent authority and jurisdiction. Prior to deployment, you should request and be given the following basic Information by the requesting agency/organization:

- Name and any subdivision of the requesting agency and POC
- Name of the Incident/Event
- Nature of the Incident/Event
- Deployment destination, contact information for POC at that location or alternate staging area
- Expected duration of the deployment (hours, days)
- Expected weather conditions
- Local resources and conditions (equipment on-hand, power, etc.)
- Availability of transportation and type
- Fuel type and availability for vehicles and generators
- Specific known equipment needs (VHF/UHF radios, antennas, HF radio/antenna, generator set)
- Food, sleeping, hygiene accommodations available
- Special personal needs (food, water, etc.)
- Suggested route of travel
- Frequencies/call signs for travel and destination

3.3.1 Go Kit

Personal Care

- Cash (potentially no working ATMs in the area)
- Alarm Clock (manual or battery powered)
- Appropriate clothing with 3 or more changes
- Personal items, toiletries, toilet paper
- Insect repellent, sunscreen, moisturizer, and hand wipes/gel
- First aid kit, medications/prescriptions
- Flashlight and extra batteries
- Keys (including site access cards/keys)
- Foul weather gear

Sustenance and Shelter

- Beverages (water) and food for 9 meals minimum
- Snack items
- Candles/electric lantern
- Waterproof matches
- Mess kit with cleaning materials
- Portable stove with extra fuel
- Shelter (mattress, pillow, sleeping bag, tent)

Communications Equipment

- Pads of paper, pencils, pens, tape, sticky-notes
- ICS Forms (201, 205, 213, 214, 217A, and 309)
- 24-hour clock
- Hand-held GPS
- Mobile and portable radio(s) as appropriate for the assignment, radio manuals, batteries, headset

- AuxComm radio programming equipment (adapters, cloning cable and/or computer, software, manuals for front panel radio programming)
- Patch cords
- Power supplies, chargers
- Standing Wave Ratio (SWR) bridge(s), antenna analyzer
- Safety glasses
- Multi-purpose knife
- Volt-Ohm Milliammeter (VOM/Multi-meter)
- Climbing harness, if applicable and appropriate
- Communications tool kit including soldering iron & solder (other than 110 volt)
- Electrical, duct, and flagging tape
- Antennas, coax, RF connectors, and proper tools
- AuxComm Mobilization Guide
- National Interoperability Field Operations Guide (NIFOG)
- Local or State Field Operation Guides
- Current Repeater Directory
- Local system coverage maps

Specifically added “Go Kit” items for the AuxComm Manager are:

- Availability, capability and contact information for local and regional AuxComm personnel
- Current SCIP and TICP for area(s) being served
- ICS Forms 211, 221 and 225

3.4 Mobilization

- Prepare your family and pets for safety and comfort
- Advise family members of your planned route and destination and emergency contact numbers/information
- Employ your checklist
- Gather the items on your checklist and verify that all are complete
- Inspect your transport vehicle for safety
- Load your Go Kit and other items into your transport vehicle
- Gather your credentials, ID, licenses, ICS forms, maps, money, and medications into a secure container and load that in plain sight
- Review your checklist again.
- Retain your checklist for demobilization checkout.
- Review weather conditions
- Make one last walk-through and review

3.5 Deployment

- Follow any instructions regarding route and travel conditions
- Remain aware of your situation, weather, road conditions, etc.
- Contact stations along the route, as appropriate, for situation updates and changes
- Maintain adequate vehicle fuel levels
- Upon arrival, contact your POC and begin your assignment
- Maintain situational awareness at all times
- Remain aware of any safety and health issues that exist or arise
- Follow the safety guidelines in this guide book

A.2 Communications Unit Contact List

Name/Position Organization	Contact Method
Name/Position:	Contact Method 1:
Organization:	Contact Method 2:
Name/Position:	Contact Method 1:
Organization:	Contact Method 2:
Name/Position:	Contact Method 1:
Organization:	Contact Method 2:
Name/Position:	Contact Method 1:
Organization:	Contact Method 2:
Name/Position:	Contact Method 1:
Organization:	Contact Method 2:
Name/Position:	Contact Method 1:
Organization:	Contact Method 2:
Name/Position:	Contact Method 1:
Organization:	Contact Method 2:
Name/Position:	Contact Method 1:
Organization:	Contact Method 2:
Name/Position:	Contact Method 1:
Organization:	Contact Method 2:
Name/Position:	Contact Method 1:
Organization:	Contact Method 2:
Name/Position:	Contact Method 1:

A.3 Local EMA Contact List

Name/Position Organization	Contact Method
Name/Position:	Contact Method 1:
Organization:	Contact Method 2:
Name/Position:	Contact Method 1:
Organization:	Contact Method 2:
Name/Position:	Contact Method 1:
Organization:	Contact Method 2:
Name/Position:	Contact Method 1:
Organization:	Contact Method 2:
Name/Position:	Contact Method 1:
Organization:	Contact Method 2:
Name/Position:	Contact Method 1:
Organization:	Contact Method 2:
Name/Position:	Contact Method 1:
Organization:	Contact Method 2:
Name/Position:	Contact Method 1:
Organization:	Contact Method 2:
Name/Position:	Contact Method 1:
Organization:	Contact Method 2:
Name/Position:	Contact Method 1:
Organization:	Contact Method 2:
Name/Position:	Contact Method 1:

A.4 State EMA Contact List

Name/Position Organization	Contact Method
Name/Position:	Contact Method 1:
Organization:	Contact Method 2:
Name/Position:	Contact Method 1:
Organization:	Contact Method 2:
Name/Position:	Contact Method 1:
Organization:	Contact Method 2:
Name/Position:	Contact Method 1:
Organization:	Contact Method 2:
Name/Position:	Contact Method 1:
Organization:	Contact Method 2:
Name/Position:	Contact Method 1:
Organization:	Contact Method 2:
Name/Position:	Contact Method 1:
Organization:	Contact Method 2:
Name/Position:	Contact Method 1:
Organization:	Contact Method 2:
Name/Position:	Contact Method 1:
Organization:	Contact Method 2:
Name/Position:	Contact Method 1:
Organization:	Contact Method 2:
Name/Position:	Contact Method 1:

Appendix B Telephone Network Communications

B.1 Priority Services

Government Emergency Telecommunications Service (GETS) and Wireless Priority Service (WPS) are priority services available to authorized government and industry personnel and critical infrastructure / key resources providers. Being an AuxComm volunteer does not qualify one to have a GETS or WPS account. AuxComm volunteers may be assigned tasks that require using another individual's or agency's GETS account, or may be expected to use WPS on an authorized cellular telephone to make emergency or high-priority telephone calls.

B.1.1 Government Emergency Telecommunications Service (GETS)

- GETS features are available on approximately 87% of the access lines in the U.S.
- GETS provides priority features, such as alternate carrier routing, High Probability of Completion, and call queuing on the local and long distance networks
- During an emergency the telephone network reserves capacity for outbound public calls from the affected area
- GETS gives authorized callers access to the reserved capacity for inbound and outbound calls
- GETS calls are exempt from long-distance restrictive network management controls
- To use GETS:
 - Dial 1-710-NCS-GETS (627-4387)
 - After the tone prompt, enter your PIN (GETS card number)
 - After the voice prompt, enter ten-digit destination number, or international number

If GETS call fails, use alternate access numbers on back of GETS card:

- AT&T: 1-888-288-4387
1-877-646-4387 (NGN-GETS)
- Verizon: 1-800-900-4387
- Sprint: 1-800-257-8373

Refer to the GETS website <http://www.dhs.gov/gets> for additional details.

B.1.2 Wireless Priority Service (WPS)

- WPS provides priority access to wireless channels in the cellular network where the call originates, placing WPS calls in queue for the next available channel if a radio channel is not immediately available
- WPS is available on all the major nationwide carriers and selected regional carriers
- WPS calls receive priority processing across the cellular network ("High Probability of Completion" special handling and routing), similar to GETS call handling
- At the destination network, WPS calls receive priority to both wireless or landline circuits. The phone receiving the call does not need WPS or GETS to receive the prioritized call
- WPS is an add-on feature subscribed on a per cellphone basis; there are per-minute usage charges and there may be a monthly subscription charge
- To use WPS on an authorized cellphone
 - Dial *272 + destination number + send

Refer to the WPS website <http://www.dhs.gov/wps> for additional details.

B.2 Text Messaging

It is possible to send an e-mail to a cellular phone which will appear as a text message. This is an alternate method which can be used if a text-capable cellular phone is not available to send a text message directly, or when the sender's cellular network is disrupted for any reason. Text messages are sent via control/data channels and may have a higher probability of reaching the desired recipient(s) when voice channels are at capacity or congested.

Using this method is a one-way format, and the sender may have no confirmation that the message was received on the desired cellular phone(s). Not all cellular phones are capable of receiving text messages. Additionally, cellular phones receiving text messages via e-mail may behave differently if the number of characters sent exceeds designated lengths. In some cases, part of the message may be stripped away, or in other cases, it may result in the message being broken into multiple text messages. The best practice is to keep the message as short as possible and include only essential information.

To send an e-mail to a cellular phone and have it appear as a text message, the sender must know the recipient's wireless carrier and cell phone number, and the recipient must be capable of receiving a text message. To send an e-mail, address the message using the list below. Substitute "number" with the recipient's 10-digit wireless telephone number. If there is more than one option for a particular wireless carrier, it is advisable to send the message to each of them.

Text Messaging	
Selected US & Canadian Cellular Text Messaging Carriers	
<i>“number” is the 10-digit telephone number</i>	
Alltel	number@alltelmessage.com or number@message.alltel.com
AT&T	number@txt.att.net or number@mms.att.net
Bell Canada (Mobility) - phone - blackberry	number@txt.bell.ca number@txt.bellmobility.ca
Centennial Wireless	number@cwemail.com
Cellular South	number@csouth1.com
Cincinnati Bell	number@gocbw.com
Metro PCS	number@mymetropcs.com or number@metropcs.sms.us
Nextel	number@messaging.nextel.com
Omnipoint	number@omnipointpcs.com
Qwest	number@qwestmp.com
Southernlinc	number @page.southernlinc.com
Sprint	number@messaging.sprintpcs.com
Suncom	number@tms.suncom.com
T-Mobile	number@tmomail.net
TracFone	number@mmst5.tracfone.com
Telus	number@msg.telus.com
U.S. Cellular	number@email.uscc.net
Verizon	number@vtext.com
Virgin Mobile	number@messaging.sprintpcs.com
Alaska	
Alaska Communications Systems (ACS)	number@msg.acsalaska.com
General Communications Inc. (GCI)	number@mobile.gci.net
Puerto Rico	

B.3 NOAA Weather Radio “All Hazards” Broadcasts

NWR broadcasts National Weather Service (NWS) warnings, watches, forecasts and other non-weather related hazard information 24 hours a day. Channels WX1-WX7 are used in the US & Canada; channels WX8-WX9 are used for Canada Marine Weather broadcasts in some areas. These channels should be programmed as wideband FM (16K0F3E) receive only. Some radio manufacturers number the US weather channels in the order they came into use, others number them in frequency order. For programming in land-mobile radios, frequency order is recommended.

**Weather Radio Broadcasts – Receive Only
(WX1-WX7 US & Canada; WX8-WX9 Canada Marine Weather)**

WX1	WX2	WX3	WX4	WX5	WX6	WX7
162.400	162.425	162.450	162.475	162.500	162.525	162.550

Marine 21B	Marine 83B
WX8	WX9
161.650	161.775

To protect equipment during a lightning storm, disconnect the coax, power, ground, and any other connections. Move the coax and other cables safely away from the equipment.

B.4 Standard Time and Frequency Broadcasts

The National Institute of Standards and Technology (NIST) operates radio stations WWV from Ft. Collins, Colorado and WWVH from Kauai, Hawaii. WWV and WWVH broadcast time and frequency information on a 24/7 basis. Broadcast information includes time announcements, standard time intervals, standard frequencies, UT1 time corrections, a BCD time code, geophysical alerts, and marine storm warnings.

Each frequency carries the same information. Multiple frequencies are used because the quality of HF reception depends on many factors. WWV and WWVH broadcast on the frequencies listed in the table below, using double sideband, amplitude modulation.

The National Research Institute of Canada operates radio station CHU to disseminate the official time on a 24/7 basis. Each minute, CHU broadcasts time data on the frequencies listed below and includes: time of day (UTC), day of year (1-366), Gregorian year (4 digits), and additional time details. CHU broadcasts time codes using full-carrier upper-sideband modulation that can be read by a computer with a Bell 103 compatible modem.

WWV / WWVH Frequencies (MHz)	CHU Frequencies (MHz)
2.5000	3.3300
5.0000	7.8500
10.0000	14.6700
15.0000	-----
20.0000 (WWV only)	-----

US AMATEUR RADIO BANDS

160 Meters (1.8 MHz)



80 Meters (3.5 MHz)

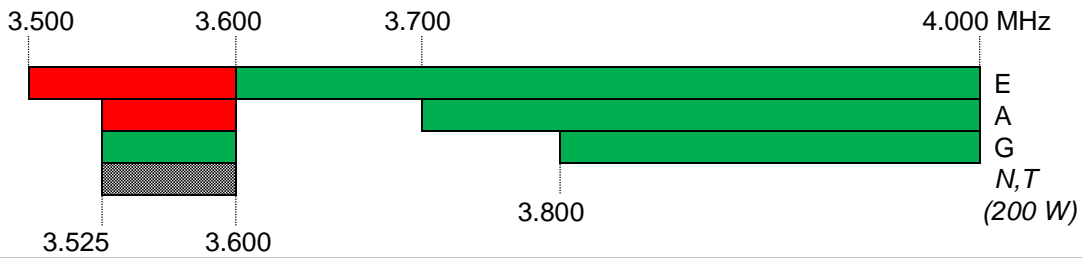

60 Meters (5.3 MHz)

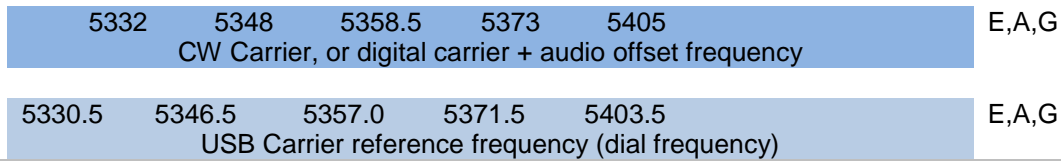

40 Meters (7 MHz)

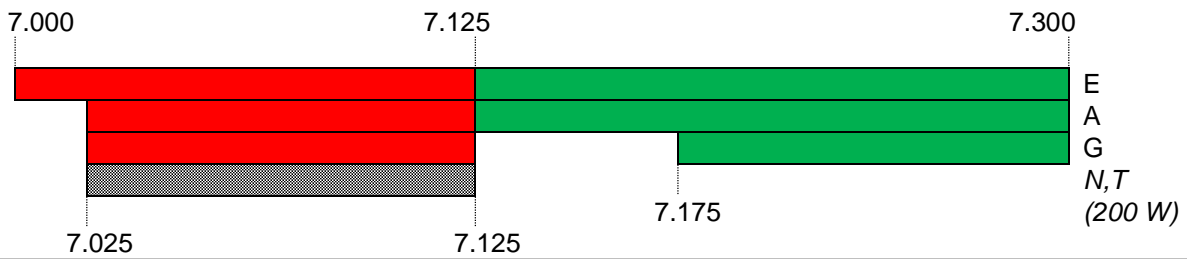

² See Page C-6 for license class codes.

US AMATEUR RADIO BANDS (cont.)

30 Meters (10.1 MHz)

Amateurs must avoid interference to foreign fixed service stations

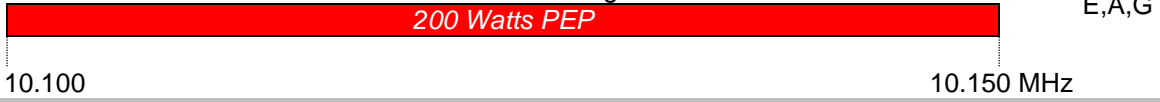

20 Meters (14 MHz)

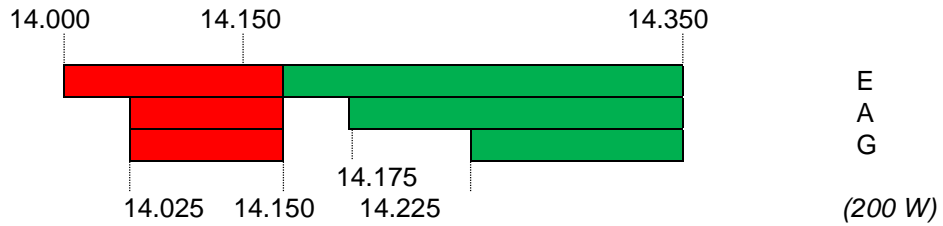

17 Meters (18 MHz)



15 Meters (21 MHz)

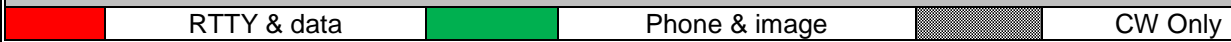
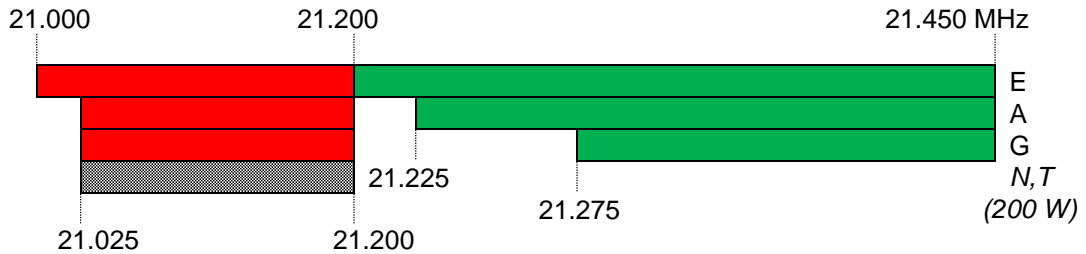

US AMATEUR RADIO BANDS (cont.)

12 Meters (24 MHz)



10 Meters (28 MHz)



6 Meters (50 MHz)



2 Meters (144 MHz)

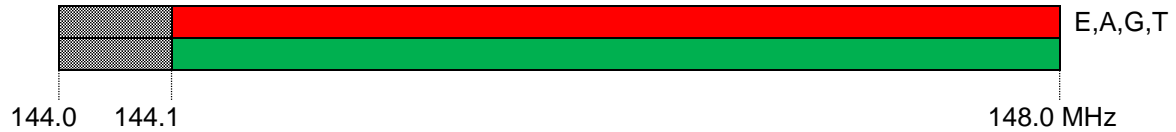

US AMATEUR RADIO BANDS (cont.)

1.25 Meters (222 MHz)



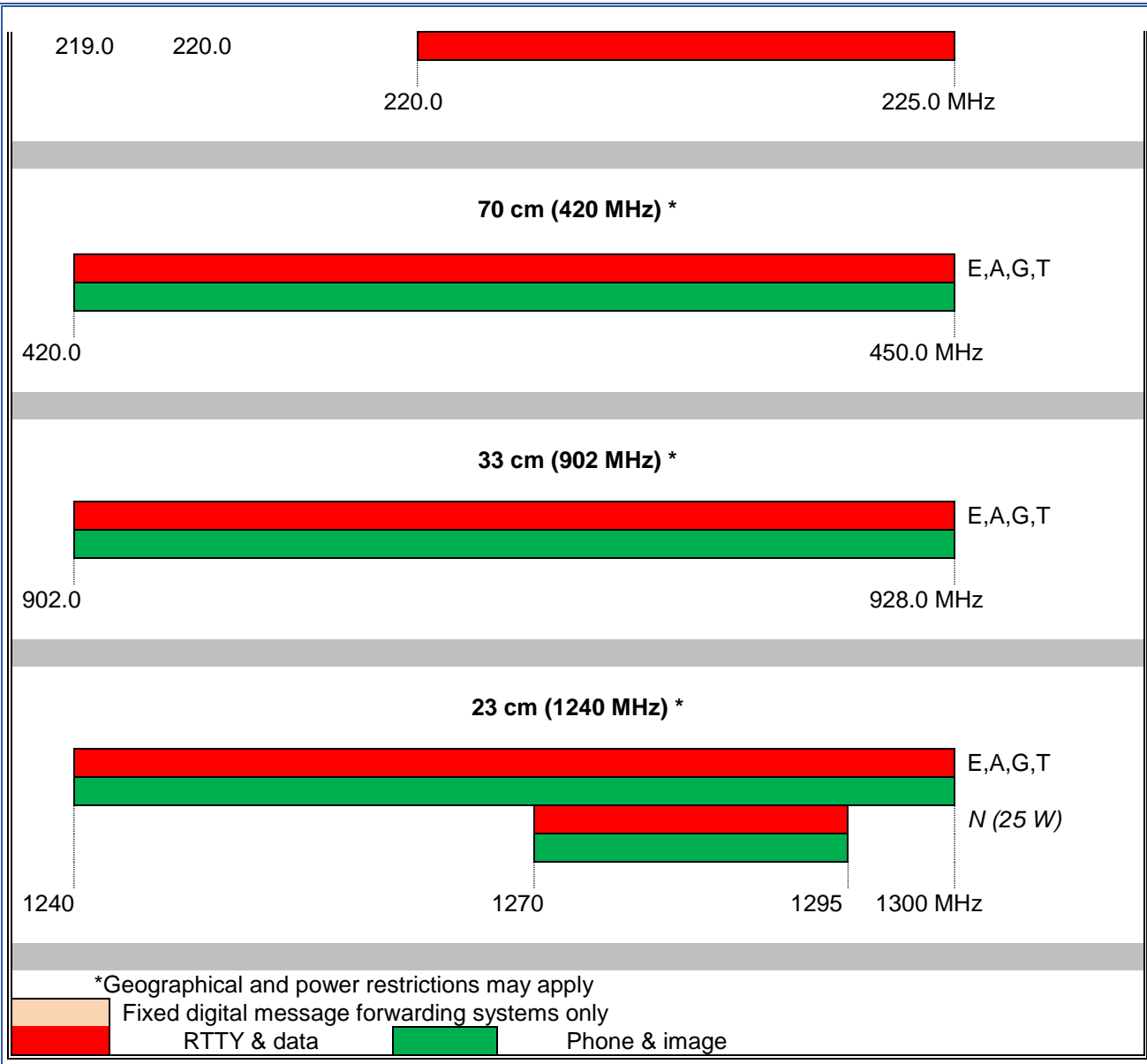

US AMATEUR RADIO BANDS (cont.)

All licensees except Novice are authorized all modes on the following frequencies:

2300-2310 MHz	47.0-47.2 GHz
2390-2450 MHz	76.0-81.0 GHz
3300-3500 MHz	122.25-123.0 GHz
5650-5925 MHz	134-141 GHz
10.0-10.5 GHz	241-150 GHz
24.0-24.25 GHz	All above 275 GHz

US AMATEUR POWER LIMITS

Different frequency privileges and power restrictions apply to operation in ITU Region 2. For additional details, refer to Title 47 CFR Part 97, Sections 97.301, 97.303, 97.305, 97.313, and Appendix I of Part 97.

In ITU Region 3, the amateur service is regulated by the FCC within the Pacific Insular territorial limits of American Samoa (seven islands), Baker Island, Commonwealth of Northern Mariana Islands, Guam Island, Howland Island, Jarvis Island, Kingman Reef, Palmyra Island (more than 50 islets) and Wake Island (Islets Peale, Wake and Wilkes).

FCC Rule 97.313 (a) An amateur station must use the minimum transmitter power necessary to carry out the desired communications. (b) No station may transmit with a transmitter power exceeding 1.5 kW PEP. [Additional restrictions apply to the 30 Meter band, and to Novice and Technician licensees.]

License Classes

E = Amateur Extra A = Advanced
G = General T = Technician N = Novice

C.2.2 UHF Amateur Radio Frequencies

70 Centimeters/UHF/420.0000-450.0000 MHz					
Location: _____					
Organization _____					
Tactical Name	Net Type(1)	RX Freq	Offset	Tone	Comments(2)

(1) Examples: Tactical Net, Medical Net, Hospital Net.....

(2) Examples:

- Specify times as Local time
- Indicate operating mode: USB, LSB, PSK31, MT63/1000, etc.
- Include routine scheduled nets, e.g., [Net Name] each Monday at 7:30pm Local Time

C.2.3 HF Amateur Radio Frequencies

160 – 10 Meters/HF/1.8000-29.7000 MHz						
Location:						
Organization						
Tactical Name	Net Type(1)	RX Freq	Offset	Tone	Comments(2)	

(1) Examples: Tactical Net, Medical Net, Hospital Net.....

(2) Examples:

- Specify times as Local time
- Indicate operating mode: USB, LSB, PSK31, MT63/1000, etc.
- Include routine scheduled nets, e.g., [Net Name] each Monday at 7:30pm Local Time

160 – 10 Meters/HF/1.8000-29.7000 MHz

Location:

Organization

Tactical Name	Net Type(1)	RX Freq	Offset	Tone	Comments(2)

(1) Examples: Tactical Net, Medical Net, Hospital Net.....

(2) Examples:

- Specify times as Local time
- Indicate operating mode: USB, LSB, PSK31, MT63/1000, etc.
- Include routine scheduled nets, e.g., [Net Name] each Monday at 7:30pm Local Time

GMRS, MURS, FRS, Industrial/Business, etc.

Location:

Organization					
Tactical Name	Net Type(1)	RX Freq	Offset	Tone	Comments(2)

(1) Examples: Tactical Net, Medical Net, Hospital Net....

(2) Examples:

- Specify times as Local time
- Indicate operating mode: USB, LSB, PSK31, MT63/1000, etc.
- Include routine scheduled nets, e.g., [Net Name] each Monday at 7:30pm Local Time

C.2.4 GMRS, MURS, FRS, Industrial/Business, etc.

C.3 Other Reference Frequencies

C.3.1 VHF Low Band

Non-Federal VHF National Interoperability Channels				
Description	Channel Name	Mobile Receive Frequency	Mobile Transmit Frequency	CTCSS Tone ±
VHF Low Band				
Law Enforcement	LLAW1	39.4600	45.8600	CSQ /156.7 (5A)
	LLAW1D	39.4600	39.4600	CSQ /156.7 (5A)
Fire (Proposed)	LFIRE2	39.4800	45.8800	CSQ /156.7 (5A)
	LFIRE2D	39.4800	39.4800	CSQ /156.7 (5A)
	LLAW3	45.8600	39.4600	CSQ /156.7 (5A)
Law Enforcement	LLAW3D	45.8600	45.8600	CSQ /156.7 (5A)
	LFIRE4	45.8800	39.4800	CSQ /156.7 (5A)
Fire (Proposed)	LFIRE4D	45.8800	45.8800	CSQ /156.7 (5A)
Frequency 39.4800 MHz is pending FCC assignment for exclusive fire intersystem use.				
± Default operation should be carrier squelch receive, CTCSS transmit. If the user can enable/disable without reprogramming the radio, the indicated CTCSS tone also could be programmed for receive, and the user instructed how and when to enable/disable.				

C.3.2 VHF High Band

Non-Federal VHF National Interoperability Channels				
VHF High Band				
Description	Channel Name	Mobile Receive Freq.	Mobile Transmit Freq.	CTCSS Tone
Calling	VCALL10	155.7525	155.7525	CSQ / 156.7 (5A) ±
Tactical	VTAC11 *	151.1375	151.1375	CSQ / 156.7 (5A) ±
Tactical	VTAC12 *	154.4525	154.4525	CSQ / 156.7 (5A) ±
Tactical	VTAC13	158.7375	158.7375	CSQ / 156.7 (5A) ±
Tactical	VTAC14	159.4725	159.4725	CSQ / 156.7 (5A) ±
Tac Rpt	VTAC33 * •	159.4725	151.1375	CSQ / 136.5 (4Z)
Tac Rpt	VTAC34 * •	158.7375	154.4525	CSQ / 136.5 (4Z)
Tac Rpt	VTAC35 •	159.4725	158.7375	CSQ / 136.5 (4Z)
Tac Rpt	VTAC36 * •	151.1375	159.4725	CSQ / 136.5 (4Z)
Tac Rpt	VTAC37 * •	154.4525	158.7375	CSQ / 136.5 (4Z)
Tac Rpt	VTAC38 •	158.7375	159.4725	CSQ / 136.5 (4Z)

*VTAC11-12, VTAC33-34, and VTAC36-37 may not be used in Puerto Rico or the USVI.

±Default operation should be carrier squelch receive, CTCSS transmit. If the user can enable/disable without re-programming the radio, the indicated CTCSS tone also could be programmed for receive, and the user instructed how and when to enable/disable.

- VTAC33-38 recommended for deployable tactical repeater use only (FCC Station Class FB2T).
- VTAC36-38 are preferred; VTAC33-35 should be used only when necessary due to interference.

All channels on this page are NARROWBAND only. Limited to 3 watts ERP above Line A or East of Line C.

C.3.3 UHF Band

Non-Federal UHF National Interoperability Repeater Channels				
Description	Channel Name	Mobile RX (MHz)	Mobile TX (MHz)	
Calling	UCALL40	453.2125	458.2125	
Calling	UCALL40D	453.2125	453.2125	
Tactical	UTAC41	453.4625	458.4625	
Tactical	UTAC41D	453.4625	453.4625	
Tactical	UTAC42	453.7125	458.7125	
Tactical	UTAC42D	453.7125	453.7125	
Tactical	UTAC43	453.8625	458.8625	
Tactical	UTAC43D	453.8625	453.8625	

Default operation should be carrier squelch receive, CTCSS 156.7(5A) transmit. If the user can enable/disable CTCSS without reprogramming the radio, the indicated CTCSS tone also could be programmed for receive, and the user instructed how and when to enable/disable. All channels on this page are NARROWBAND only. Limited to 3 watts ERP above Line A or East of Line C.

C.3.4 700 MHz Band (Digital Use Only)

700 MHz Interoperability Channels				
FCC Channel (Subscriber Load)		Transmit and Receive Frequencies	Primary Use	Channel Name
Receive Ch.	Transmit Ch.			
23-24	983-984	799.14375	General	7TAC51
	23-24	769.14375	Public Safety	7TAC51D
39-40	999-1000	799.24375	Calling Channel	7CALL50
	39-40	769.24375		7CALL50D
63-64	1023-1024	799.39375	EMS	7MED65
	63-64	769.39375		7MED65D
79-80	1039-1040	799.49375	EMS	7MED66
	79-80	769.49375		7MED66D
103-104	1063-1064	799.64375	General	7TAC52
	103-104	769.64375	Public Safety	7TAC52D
119-120	1079-1080	799.74375	General	7TAC55
	119-120	769.74375	Public Safety	7TAC55D
143-144	1103-1104	799.89375	Fire	7FIRE63
	143-144	769.89375		7FIRE63D
159-160	1119-1120	799.99375	Fire	7FIRE64
	159-160	769.99375		7FIRE64D
183-184	1143-1144	800.14375	General	7TAC53
	183-184	770.14375	Public Safety	7TAC53D
199-200	1159-1160	800.24375	General	7TAC56
	199-200	770.24375	Public Safety	7TAC56D
223-224	1183-1184	800.39375	Law	7LAW61
	223-224	770.39375	Enforcement	7LAW61D

FCC Channel (Subscriber Load)		Transmit and Receive Frequencies	Primary Use	Channel Name
Receive Ch.	Transmit Ch.			
239-240	1199-1200	800.49375	Law	7LAW62
	239-240	770.49375	Enforcement	7LAW62D
263-264	1223-1224	800.64375	General	7TAC54
	263-264	770.64375	Public Safety	7TAC54D
279-280	1239-1240	800.74375	Mobile Data	7DATA69
	279-280	770.74375		7DATA69D
303-304	1263-1264	800.89375	Mobile	7MOB59
	303-304	770.89375	Repeater	7MOB59D
319-320	1279-1280	800.99375	Other Public	7GTAC57
	319-320	770.99375	Service	7GTAC57D
641-642	1601-1602	803.00625	EMS	7MED86
	641-642	773.00625		7MED86D
657-658	1617-1618	803.10625	General	7TAC71
	657-658	773.10625	Public Safety	7TAC71D
681-682	1641-1642	803.25625	Calling	7CALL70
	681-682	773.25625	Channel	7CALL70D
697-698	1657-1658	803.35625	EMS	7MED87
	697-698	773.35625		7MED87D
721-722	1681-1682	803.50625	Fire	7FIRE83
	721-722	773.50625		7FIRE83D
737-738	1697-1698	803.60625	General	7TAC72
	737-738	773.60625	Public Safety	7TAC72D

FCC Channel (Subscriber Load)		Transmit and Receive Frequencies	Primary Use	Channel Name
Receive Ch.	Transmit Ch.			
761-762	1721-1722	803.75625	General	7TAC75
	761-762	773.75625	Public Safety	7TAC75D
777-778	1737-1738	803.85625	Fire	7FIRE84
	777-778	773.85625		7FIRE84D
801-802	1761-1762	804.00625	Law	7LAW81
	801-802	774.00625	Enforcement	7LAW81D
817-818	1777-1778	804.10625	General	7TAC73
	817-818	774.10625	Public Safety	7TAC73D
841-842	1801-1802	804.25625	General	7TAC76
	841-842	774.25625	Public Safety	7TAC76D
857-858	1817-1818	804.35625	Law	7LAW82
	857-858	774.35625	Enforcement	7LAW82D
881-882	1841-1842	804.50625	Mobile	7MOB79
	881-882	774.50625	Repeater	7MOB79D
897-898	1857-1858	804.60625	General	7TAC74
	897-898	774.60625	Public Safety	7TAC74D
921-922	1881-1882	804.75625	Mobile Data	7DATA89
	921-922	774.75625		7DATA89D
937-938	1897-1898	804.85625	Other Public Service	7GTAC77
	937-938	774.85625		7GTAC77D

12.5 kHz narrowband channels shown as odd-even channel pairs of 6.25 kHz channels.

C.3.5 800 MHz Band

Non-Federal 800 MHz National Mutual Aid Repeater Channels			
Description	Ch. Name	Mobile RX (MHz)*	Mobile TX (MHz)*
Calling	8CALL90	851.0125 (866.0125)	806.0125 (821.0125)
Calling – Direct	8CALL90D	851.0125 (866.0125)	851.0125 (866.0125)
Tactical	8TAC91	851.5125 (866.5125)	806.5125 (821.5125)
Tactical – Direct	8TAC91D	851.5125 (866.5125)	851.5125 (866.5125)
Tactical	8TAC92	852.0125 (867.0125)	807.0125 (822.0125)
Tactical – Direct	8TAC92D	852.0125 (867.0125)	852.0125 (867.0125)
Tactical	8TAC93	852.5125 (867.5125)	807.5125 (822.5125)
Tactical – Direct	8TAC93D	852.5125 (867.5125)	852.5125 (867.5125)
Tactical	8TAC94	853.0125 (868.0125)	808.0125 (823.0125)
Tactical – Direct	8TAC94D	853.0125 (868.0125)	853.0125 (868.0125)

Default operation should be carrier squelch receive, CTCSS 156.7(5A) transmit. If the user can enable/disable CTCSS without reprogramming the radio, the indicated CTCSS tone could also be programmed for receive, and the user instructed how and when to enable/disable.

*The frequency in parenthesis, which is 15 MHz higher, is the frequency used before rebanding - channel names were ICALL, ITAC1 - ITAC4. Wideband FM 20K0F3E before and after rebanding.

NOTES:

C.3.6 NOAA All-Hazards Alert Radio – Event Codes

EAS Event (NWR-SAME) Codes		
Weather-Related Events	NWR-SAME Code	Status
Blizzard Warning	BZW	Operational
Coastal Flood Watch	CFA	NWS implementation Fall 2003
Coastal Flood Warning	CFW	NWS implementation Fall 2003
Dust Storm Warning	DSW	NWS implementation Fall 2003
Flash Flood Watch	FFA	Operational
Flash Flood Warning	FFW	Operational
Flash Flood Statement	FFS	Operational
Flood Watch	FLA	Operational
Flood Warning	FLW	Operational
Flood Statement	FLS	Operational
High Wind Watch	HWA	Operational
High Wind Warning	HWW	Operational
Hurricane Watch	HUA	Operational
Hurricane Warning	HUW	Operational
Hurricane Statement	HLS	Operational
Severe Thunderstorm Watch	SVA	Operational
Severe Thunderstorm Warning	SVR	Operational
Severe Weather Statement	SVS	Operational
Special Marine Warning	SMW	NWS implementation Fall 2003
Special Weather Statement	SPS	Operational
Tornado Watch	TOA	Operational
Tornado Warning	TOR	Operational

Tropical Storm Watch	TRA	NWS implementation Fall 2003
Tropical Storm Warning	TRW	NWS implementation Fall 2003
Tsunami Watch	TSA	Operational
Tsunami Warning	TSW	Operational
Winter Storm Watch	WSA	Operational
Winter Storm Warning	WSW	Operational
Non-Weather-Related Events	NWR-SAME Code	Status
<i>National Codes-required</i>		
Emergency Action Notification	EAN	Operational
Emergency Action Termination	EAT	Operational
National Information Center	NIC	Operational
<i>State and Local Codes-optional</i>		
Avalanche Watch	AVA	NWS implementation Fall 2003
Avalanche Warning	AVW	NWS implementation Fall 2003
Child Abduction Emergency	CAE	NWS implementation Fall 2003
Civil Danger Warning	CDW	NWS implementation Fall 2003
Civil Emergency Message	CEM	Operational
Earthquake Warning	EQW	NWS implementation Fall 2003
Evacuation Immediate	EVI	Operational
Fire Warning	FRW	NWS implementation Fall 2003
Hazardous Materials Warning	HMW	NWS implementation Fall 2003
Law Enforcement Warning	LEW	NWS implementation Fall 2003
Local Area Emergency	LAE	NWS implementation Fall 2003
911 Telephone Outage Emergency	TOE	NWS implementation Fall 2003

Nuclear Power Plant Warning	NUW	NWS implementation Fall 2003
Radiological Hazard Warning	RHW	NWS implementation Fall 2003
Shelter in Place Warning	SPW	NWS implementation Fall 2003
Volcano Warning	VOW	NWS implementation Fall 2003
Administrative Events	NWR-SAME Code	Status
Administrative Message	ADR	Operational
National Periodic Test	NPT	Operational
Network Message Notification	NMN	NWS implementation Fall 2003
Practice/Demo Warning	DMO	Operational
Required Monthly Test	RMT	Operational
Required Weekly Test	RWT	Operational

C.3.7 Aviation Frequencies (AM)

COMMONLY USED FREQUENCIES

Aviation Frequencies

121.5 Emergency & Distress

122.9 SAR Secondary and Training

123.1 SAR

122.925 – for use only for communications with or between aircraft when coordinating natural resources programs of Federal or State natural resources agencies, including forestry management and fire suppression, fish and game management and protection and environmental monitoring and protection.

Typical Uses	Fixed Wing	Rotary Wing
Air-to-Air	122.750 F	
	122.850 M	122.850 M
	122.925 M	122.925 M
	122.975 U	122.975 U
		123.025 A
	123.075 U	123.075 U
Air-to-Ground	122.850 M	122.850 M
	122.925 M	122.925 M
	122.975 U	122.975 U
		123.025 A
	123.075 U	123.075 U

A – Helicopter air-to-air, air traffic control operations.

F – Fixed-wing air-to-air. M – Multicom. U – Unicom.

Ask FAA/FCC for emergency use of 123.3 or 123.5 (flight training).

All frequencies on this page use AM (emission designator 6K00A3E).

NOTES:

C.3.8 Marine Frequencies

VHF Marine Channel Listing

This chart summarizes a portion of the FCC rules –47CFR 80.371(c) and 80.373(f)

Type of Message	Appropriate Channels *
DISTRESS SAFETY AND CALLING - Use this channel to get the attention of another station (calling) or in emergencies (distress and safety).	16
INTERSHIP SAFETY - Use this channel for ship-to-ship safety messages and for search and rescue messages to ships and aircraft of the Coast Guard.	6
COAST GUARD LIAISON - Use this channel to talk to the Coast Guard (but first make contact on Channel 16).	22A
COAST GUARD - These channels are Coast Guard working channels, not available to commercial or non-commercial vessels for normal use.	21A, 23A, 81A, 83A
U.S. Government - Environmental protection operations.	81A
U.S. Government - This channel is a working channel for U.S. Government vessels and U.S. Government coast stations only.	82A
NONCOMMERCIAL - Working channels for voluntary boats. Messages must be about the needs of the ship. Typical uses include fishing reports, rendezvous, scheduling repairs and berthing information. Use Channels 67 and 72 only for ship-to-ship messages.	9 ⁶ , 67 ⁹ , 68, 69, 71 ⁸ , 72, 78A, 79A ⁴ , 80 ⁴
COMMERCIAL - Working channels for working ships only. Messages must be about business or the needs of the ship. Use channels 8, 67, 72 and 88A only for ship-to-ship messages.	1 ⁵ , 7A, 8, 9, 10, 11, 18A, 19A, 63 ⁵ , 67 ⁷ , 79A, 80A, 88A ¹
PUBLIC CORRESPONDENCE (MARINE OPERATOR) - Use these channels to call the marine operator at a public coast station. By contacting a public coast station, you can make and receive calls from telephones on shore. Except for distress calls, public coast stations usually charge for this service.	24, 25, 26, 27, 28, 84, 85, 86

Type of Message	Appropriate Channels *
<p>PORT OPERATIONS - These channels are used in directing the movement of ships in or near ports, locks or waterways. Messages must be about the operational handling movement and safety of ships. In certain major ports, Channels 11, 12 and 14 are not available for general port operations messages. Use channel 20 only for ship-to-coast messages. Channel 77 is limited to intership communications to and from pilots.</p>	<p>1⁵, 5³, 12, 14, 20, 63⁵, 65, 66, 73, 74, 75¹⁰, 76¹⁰, 77</p>
<p>NAVIGATIONAL - (Also known as the bridge-to-bridge channel.) This channel is available to all ships. Messages must be about ship navigation, for example, passing or meeting other ships. You must keep your messages short. Your power output must not be more than one watt. This is also the main working channel at most locks and drawbridges.</p>	<p>13, 67</p>
<p>MARITIME CONTROL - This channel may be used to talk to ships and coast stations operated by state or local governments. Messages must pertain to regulation and control, boating activities, or assistance to ships.</p>	<p>17</p>
<p>DIGITAL SELECTIVE CALLING - Use this channel for distress and safety calling and for general purpose calling using only digital selective calling techniques.</p>	<p>70</p>
<p>WEATHER - On these channels you may receive weather broadcasts of the National Oceanic and Atmospheric Administration. These channels are only for receiving. You cannot transmit on them.</p>	<p>WX-1 through WX-7</p>
Footnotes	
<p>1. Not available in the Great Lakes, St. Lawrence Seaway, or the Puget Sound and the Strait of Juan de Fuca and its approaches.</p>	
<p>2. Only for use in the Great Lakes, St. Lawrence Seaway, and Puget Sound and the Strait of Juan de Fuca and its approaches.</p>	
<p>3. Available only in the Houston and New Orleans areas.</p>	
<p>4. Available only in the Great Lakes.</p>	
<p>5. Available only in the New Orleans area.</p>	
<p>6. Available for intership, ship, and coast general purpose calling by noncommercial ships.</p>	
<p>7. Available only In the Puget Sound and the Strait of Juan de Fuca.</p>	

VHF Marine Channels & Frequencies

Source: <http://www.navcen.uscg.gov/?pageName=mtVhf>

Channel Number *	Ship Transmit MHz	Ship Receive MHz	Use
01A	156.050	156.050	Port Operations and Commercial, VTS. Available only in New Orleans/Lower Mississippi area
05A	156.250	156.250	Port Operations or VTS in the Houston, New Orleans and Seattle areas
6	156.300	156.300	Intership Safety
07A	156.350	156.350	Commercial
8	156.400	156.400	Commercial (Intership only)
9	156.450	156.450	Boater Calling. Commercial and Non-Commercial
10	156.500	156.500	Commercial
11	156.550	156.550	Commercial. VTS in selected areas
12	156.600	156.600	Port Operations. VTS in selected areas
13	156.650	156.650	Intership Navigation Safety (Bridge-to-bridge). Ships >20m length maintain a listening watch on this channel in US waters
14	156.700	156.700	Port Operations. VTS in selected areas
15	--	156.750	Environmental (Receive only). Used by Class C EPIRBs
16	156.800	156.800	International Distress, Safety and Calling. Ships required to carry radio, USCG, and most coast stations maintain a listening watch on this channel
* "A" indicates simplex use of the ship station transmit frequency of an international duplex channel. Used in U.S. waters only.			
17	156.850	156.850	State & Local Government Maritime Control
18A	156.900	156.900	Commercial
19A	156.950	156.950	Commercial

Channel Number *	Ship Transmit MHz	Ship Receive MHz	Use
20	157.000	161.600	Port Operations (duplex)
20A	157.000	157.000	Port Operations
21A	157.050	157.050	U.S. Coast Guard only
22A	157.100	157.100	Coast Guard Liaison and Maritime Safety Information Broadcasts. Broadcasts announced on channel 16.
23A	157.150	157.150	U.S. Coast Guard only
24	157.200	161.800	Public Correspondence (Marine Operator)
25	157.250	161.850	Public Correspondence (Marine Operator)
26	157.300	161.900	Public Correspondence (Marine Operator)
27	157.350	161.950	Public Correspondence (Marine Operator)
28	157.400	162.000	Public Correspondence (Marine Operator)
63A	156.175	156.175	Port Operations and Commercial, VTS. Available only in New Orleans/Lower Mississippi area
65A	156.275	156.275	Port Operations
66A	156.325	156.325	Port Operations
67	156.375	156.375	Commercial. Used for bridge-to-bridge communications in lower Mississippi River. Intership only
68	156.425	156.425	Non-Commercial
69	156.475	156.475	Non-Commercial
70	156.525	156.525	Digital Selective Calling (voice communications not allowed)
71	156.575	156.575	Non-Commercial
72	156.625	156.625	Non-Commercial (intership only)

Channel Number *	Ship Transmit MHz	Ship Receive MHz	Use
73	156.675	156.675	Port Operations
74	156.725	156.725	Port Operations
77	156.875	156.875	Port Operations (intership only)
78A	156.925	156.925	Non-Commercial
79A	156.975	156.975	Commercial. Non-Commercial in Great Lakes only
80A	157.025	157.025	Commercial. Non-Commercial in Great Lakes only
81A	157.075	157.075	U.S. Government only - Environmental protection operations
82A	157.125	157.125	U.S. Government only
83A	157.175	157.175	U.S. Coast Guard only
84	157.225	161.825	Public Correspondence (Marine Operator)
85	157.275	161.875	Public Correspondence (Marine Operator)
86	157.325	161.925	Public Correspondence (Marine Operator)
87A	157.375	157.375	Public Correspondence (Marine Operator)
88A	157.425	157.425	Commercial, intership only
AIS1	161.975	161.975	Automatic Identification System (AIS)
AIS2	162.025	162.025	Automatic Identification System (AIS)

NOTES:

C.3.9 MULTI-USE RADIO SERVICE (MURS)

151.820 MHz

151.880 MHz

151.940 MHz

154.570 MHz (shared with business band)

154.600 MHz (shared with business band)

- Maximum power output 2 watts.
- Narrowband on 151 MHz frequencies, narrowband or wideband on the 154 MHz frequencies.
- External gain antennas may be used (must be no more than 60 feet above ground or 20 feet above the structure on which it is mounted).
- Voice or data (but not store-and-forward packet operation).
- Personal or business use.
- No license required.

C.3.10 Citizens Band (CB) Frequencies

Ch	MHz	Ch	MHz	Ch	MHz	Ch	MHz	Ch	MHz
1	26.965	2	26.975	3	26.985	4	27.005	5	27.015
6	27.025	7	27.035	8	27.055	9	27.065	10	27.075
11	27.085	12	27.105	13	27.115	14	27.125	15	27.135
16	27.155	17	27.165	18	27.175	19	27.185	20	27.205
21	27.215	22	27.225	23	27.255	24	27.235	25	27.245
26	27.265	27	27.275	28	27.285	29	27.295	30	27.305
31	27.315	32	27.325	33	27.335	34	27.345	35	27.355
36	27.365	37	27.375	38	27.385	39	27.395	40	27.405
*	26.995	*	27.045	*	27.095	*	27.145	*	27.195
* Remote Control Channels									

C.3.11 Common Business Frequency Table

Common Business Frequencies

IS=Special Industrial IB=Business

27.49	IB	Itinerant
35.04	IB	Itinerant
43.0400	IS	Itinerant
151.5050	IS	Itinerant
151.6250	IB	RED DOT Itinerant
151.9550	IB	PURPLE DOT
152.8700	IS	Itinerant
154.5700	IB	BLUE DOT (also MURS)
154.6000	IB	GREEN DOT (also MURS)
158.4000	IS	Itinerant
451.8000	IS	Itinerant
456.8000	IS	Itinerant
464.5000	IB	BROWN DOT Itinerant 35w.
464.5500	IB	YELLOW DOT Itinerant 35w.
467.7625	IB	J DOT
467.8125	IB	K DOT
467.8500	IB	SILVER STAR
467.8750	IB	GOLD STAR
467.9000	IB	RED STAR
467.9250	IB	BLUE STAR
469.5000	IB	Simplex or input to 464.500 if repeater. Itinerant 35 w. max
469.5500	IB	Simplex or input to 464.550 if repeater. Itinerant 35 w. max

C.3.12 Railroad Frequencies

160.215(ch.7)-161.565(ch.97), every 15 kHz

Interstitial narrowband channels between ch. 2-97 are offset 7.5 kHz.

161.205 Railroad Police Mutual Aid

(Wideband: channel 73; narrowband: channel 073)

Ch. 2-6 are used in Canada only:

159.810 159.930 160.050 160.185 160.200

452.325 / 457.325

452.375 / 457.375

452.425 / 457.425

452.475 / 457.475

452.775 / 457.775

452.825 / 457.825

452.875 / 452.875

452.900 / 457.900

452.8500

452.8375 - low power

452.8625 - low power

452.8875 - low power

(telemetry / remote control / remote indicator frequencies omitted)

C.3.13 Search and Rescue (SAR) Frequencies

Land SAR

Typical frequencies are: 155.160, .175, .205, .220, .235, .265, .280, or .295
If CTCSS is required try 127.3 Hz (3A).

Water SAR

156.300 (VHF Marine channel 06) Safety and SAR
156.450 (VHF Marine channel 09) Non-commercial supplementary calling
156.800 (VHF Marine channel 16) DISTRESS and calling
156.850 (VHF Marine channel 17) State control
157.100 (VHF Marine channel 22A) Coast Guard Liaison

USCG Auxiliary

138.475, 142.825, 143.475, 149.200, 150.700

Air SAR

3023, 5680, 8364 kHz (lifeboat/survival craft),
4125 kHz (distress/safety with ships and coast stations)
121.5 MHz emergency and distress
122.9 MHz SAR secondary & training
123.1 MHz SAR primary

USCG/DOD Joint SAR

345.0 MHz AM initial contact, 282.8 MHz AM working

Military SAR

40.50 wideband FM US Army/USN SAR
138.450 AM 138.750 AM USAF SAR

VHF Marine Channels

6, 9, 15, 16, 21A, 23A, 81A, 83A

C.3.14 Emergency Support Functions

ESF #	FUNCTION	ESF #	FUNCTION
ESF #1	Transportation	ESF #9	Urban Search & Rescue
ESF #2	Communications	ESF #10	Oil & Hazardous Materials Response
ESF #3	Public Works and Engineering	ESF #11	Agriculture and Natural Resources
ESF #4	Firefighting	ESF #12	Energy
ESF #5	Emergency Management	ESF #13	Public Safety and Security
ESF #6	Mass Care, Housing, and Human Services	ESF #14	Long-Term Community Recovery
ESF #7	Resource Support	ESF #15	External Affairs
ESF #8	Public Health and Medical Services	Telephone number for all ESFs 202-646-2828	

Appendix D Field Expedient Antennas

D.1 Field Expedient Antennas

There are many antenna designs that are suitable for field-expedient use and some may be constructed on-site. Several simple types are depicted. Note, as in all circumstances, care must be given to safety implications when constructing and deploying any antennas, including those shown.

D.1.1 Ground Plane Antennas (VHF/UHF)

Field expedient antennas for VHF/UHF use are typically quarter-wavelength vertically polarized and consist of a radiating element and a counterpoise. These include a simple VHF “ground plane” vertical, using 19.5 inches of the center conductor of the coaxial cable as the radiator and four 19 inch wires attached to the coaxial cable shield as the counterpoise (ground plane) (see Figure 1 and Figure 2). The counterpoise wires can be fitted to an SO-239 connector if available, or may be simply wrapped around the braid and soldered. Form a loop or hook at the top of the center conductor for hanging the antenna. Counterpoise wires should be bent downward such that they form a 45 degree angle with respect to the horizontal plane.

A similar UHF antenna can be constructed by cutting the vertical element to 9 inches, making the counterpoise wires 8.5 inches in length and also bent downward at a 45 degree angle.

When installing dipole antennas between two trees, ensure that you leave enough slack to account for the trees moving in windy conditions. If the dipole is too tight, the trees will not be forgiving.

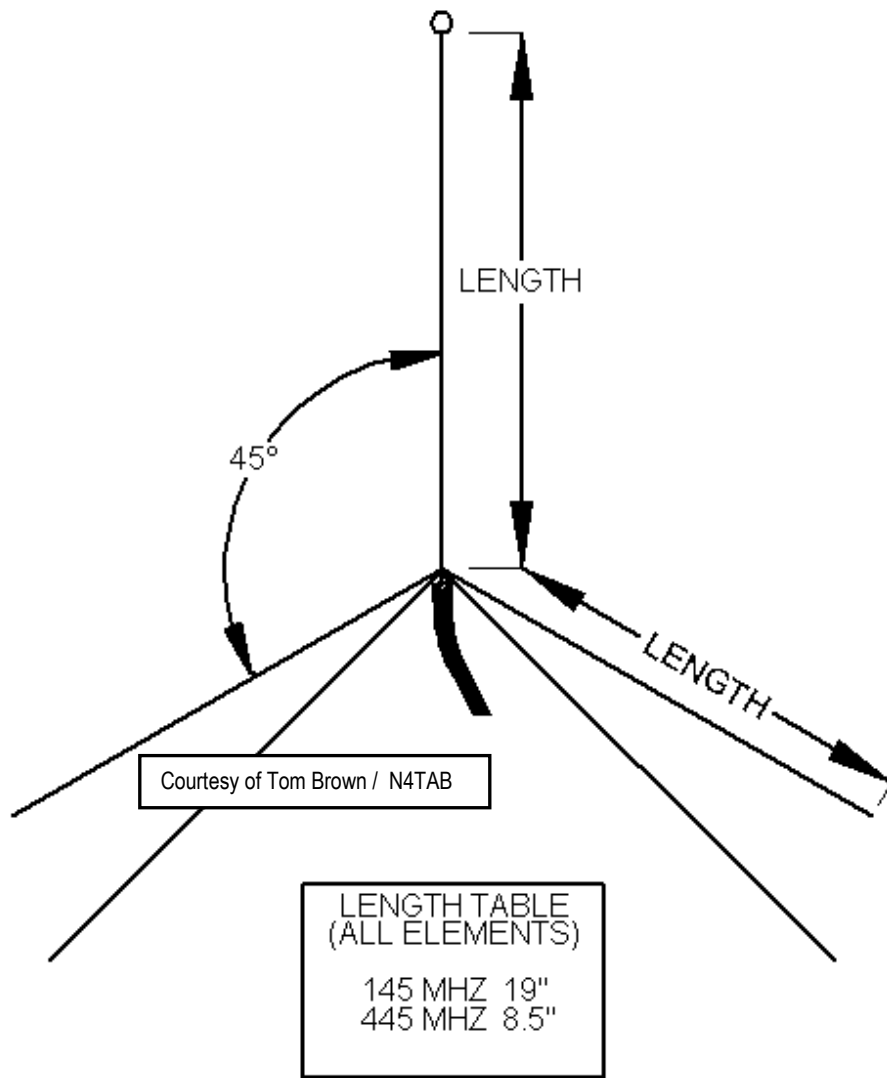

Figure 1. VHF and UHF Ground Plane Design



Figure 2. Example of VHF Ground Plane Antenna

D.1.2 Coaxial Sleeve Antennas (VHF)

Another useful and simple antenna for VHF operation is a coaxial sleeve antenna that uses the center conductor of the coaxial cable as the radiating element and the shield braid of the coaxial cable as the counterpoise. In this example, the outer jacket is removed to expose 19.5 inches of the shield braid. The braid is compressed to expand its diameter and rolled inside-out over the outer jacket, forming a coaxial sleeve. This sleeve is stretched tightly downward and secured to the outer jacket with tape or a cable tie. The insulation surrounding the center conductor is trimmed away to expose the bare center conductor wire. Make a loop or hook at the top of the center conductor for hanging the antenna.

A similar UHF antenna can be constructed by cutting the vertical element to 9 inches and making the coaxial sleeve 8.5 inches in length.

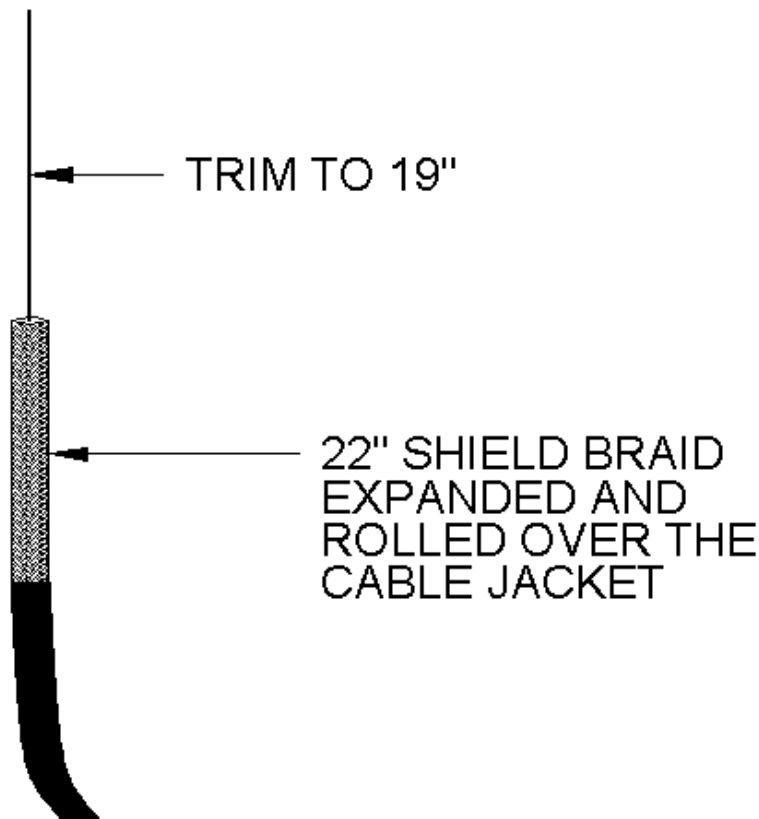

Figure 3. Coaxial Sleeve Antenna Design



Courtesy of Tom Brown / N4TAB

Figure 4. Example of VHF Coaxial Sleeve Antenna

D.1.3 Dipole Antennas (HF)

Field expedient HF antennas are often simple dipoles or inverted-V dipoles. Dipoles are typically made from 2 equal lengths of wire attached to a center insulator where the coaxial cable or ladder line is attached and the outer ends hung between 2 anchor points using insulators and cord or heavy nylon string-trimmer line which serves both as an end insulator and a support line. If available, a center support line can be used to relieve strain on the other support lines. Center and end insulators can be commercial items or made from any non-conducting material such as the plastic cap from a water bottle or from plastic strips cut from a disposable water bottle.

Single-band dipoles are among the easiest antennas to build. All you need is some stranded, copper wire (insulated or non-insulated) and three plastic or ceramic insulators. A 1/2-wavelength dipole is made up of two pieces of wire, each 1/4-wavelength long.

Calculating the lengths of the 1/2-wavelength wires is simple. Just grab a calculator and perform the following bit of division:

$$\text{Length (feet)} = 468/\text{frequency (MHz)}$$

Note: The functional difference between insulated and non-insulated wire is that the insulation adds dielectric loading. This results in the radial being electrically longer by roughly 4%.

You should add about six inches to the results of your calculations. You'll need that length margin to trim and tune for the lowest SWR. (SWR stands for Standing Wave Ratio). It is measured with a device known as an SWR meter. Many modern transceivers include SWR meters, or you can purchase them separately. An ideal SWR is 1:1.

Join the two wires in the center with an insulator, then place insulators at both ends. Solder the center conductor of your coaxial cable feed line to one side of the center insulator. (It doesn't matter which side.) Solder the shield braid of your cable to the other side. Connect ropes, nylon string or whatever to the end insulators and haul your antenna skyward. Get it as high as you can and as straight as possible. Don't hesitate to bend your dipole if that's what it takes to make it fit.

Once your dipole is safely airborne, power up your transmitter and check the SWR at many points throughout the band. (It helps if you can plot the results on graph paper.) If you see that the SWR is getting lower as you move lower in frequency, your antenna is too long. Trim a couple of inches from each end and try again. On the other hand, if you see that the SWR is getting higher as you go lower in frequency, your antenna is too short. You'll need to add wire to both ends and make another series of measurements.

When you've finished trimming your dipole, you'll probably end up with an SWR of 1.5:1 or less at the center frequency, rising to 2:1 or somewhat higher at either end of the band. Don't expect a 1:1 SWR across the entire band. By carefully trimming the antenna you can move the low-SWR portion to cover your favorite frequencies.

Suggested Dipole Wire Length (Based on 14 AWG Wire)³

Frequency	Non-Insulated Wire (ft)	Insulated Wire (ft)
1.900 MHz	246.4	236.4
3.800 MHz	123.2	118.2
3.900 MHz	120.0	114.0
5.370 MHz	87.2	42.8
7.200 MHz	65.0	61.8
14.200 MHz	33.0	31.4

³ The lengths shown are the overall length. Each leg of the dipole is one half (1/2) of the length shown.

D.2 Emergency Center of Activity Frequencies for Amateur Radio

The IARU (International Amateur Radio Union) Region 2 (American Continent) has adopted band plans for various activities within the Amateur Radio frequency allocations. The plan adopted October 8, 2008 suggests the following frequencies as the Center-of-Activity for Emergency communications in Region 2.

BAND	DIAL FREQUENCY (kHz)
80M	3750, 3985
40M	7240, 7275
*60M ⁴	5330.5, 5346.5, 5357.0, 5371.5, 5403.5
20M	14300 (Global)
17M	18160 (Global)
15M	21360 (Global)

The International Amateur Radio Union (IARU) published a list of “Emergency Center of Activity Frequencies” within the 15, 17, 20, 40, and 80 meter amateur radio frequency bands. The Emergency Center of Activity Frequency list is based on recommendations and agreements following Global Amateur Radio Emergency Communications conferences.

Emergency Center of Activity frequencies are generally known frequencies agreed upon across multiple IARU regions. These frequencies are points of activity where operators may be expected to congregate and/or operate in times of emergency. There is no guarantee the frequencies will be monitored or active.

Best practices relating to the use of Emergency Center of Activity frequencies includes the following:

- Establish contact on the desired frequency as appropriate, then move to, or near, the Center of Activity frequencies to pass traffic or conduct operations
- Tune to or near Center of Activity frequencies for emergency operations

NOTES:

⁴ Note that the 60M frequencies are not part of the IARU recommendations; those are US frequencies as allocated by the FCC under Part 97 of their Rules and regulations

Appendix E Connectors

E.1 RJ-45 Wiring

		<i>T568A (less common)</i>		T568B (more common)	
Pin	Pair	<i>Color</i>	<i>Name</i>	Color	Name
1	2	<i>white/ green</i>	<i>RecvData+</i>	white/orange	TxData +
2	2	<i>green</i>	<i>RecvData-</i>	orange	TxData -
3	3	<i>white/orange</i>	<i>TxData +</i>	white/green	RecvData+
4	1	<i>blue</i>		blue	
5	1	<i>white/blue</i>		white/blue	
6	3	<i>orange</i>	<i>TxData -</i>	green	RecvData-
7	4	<i>white/brown</i>		white/brown	
8	4	<i>brown</i>		brown	

Note that the odd pin numbers are always the white-with-stripe color.

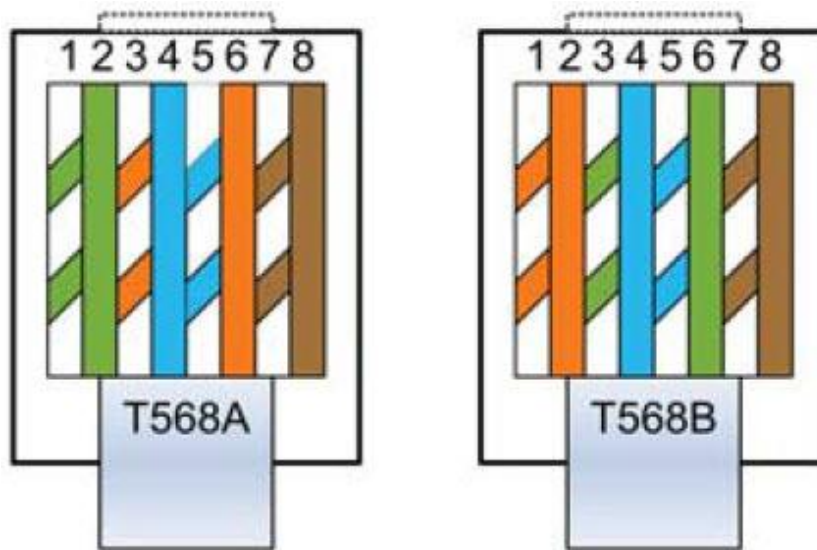

A straight cable has both ends the same – both T568A (older standard) or both T568B (newer Standard). A crossover cable has one end wired as T568A, the other as T568B.

E.2 RS-232 Connectors (DB9 and DB25)

“Front” refers to the ends with the pins; “rear” refers to the end with the cable. The following is a view of the pins. Looking at the front of the female connector (rear of male):

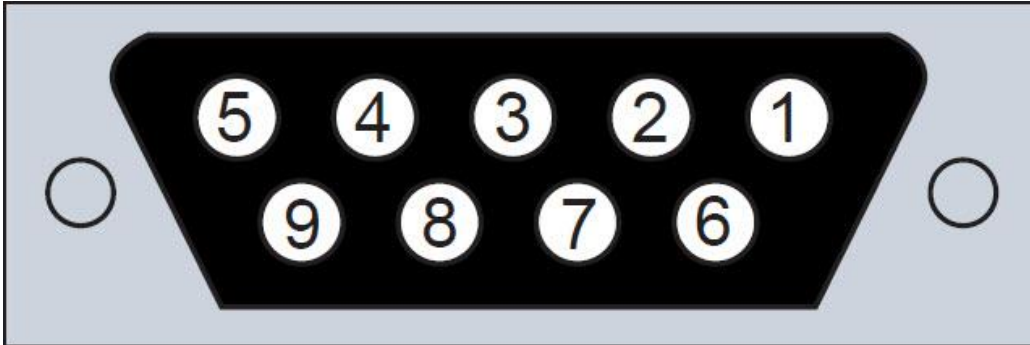

Same for DB25, except top pins 13-1, bottom 25-14 (left to right)

DB9	DB25	Signal
1	8	Carrier Detect
2	3	Receive Data
3	2	Transmit Data*
4	20	Data Terminal Ready*
5	1,7	Ground **
6	6	Data Set Ready
7	4	Request to Send*
8	5	Clear to Send
9	22	Ring Indicator
* An output from the computer to the outside world.		
** On the DB25, 1 is the protective ground, 7 is the signal ground.		

E.3 RF Connectors

BNC Banana Male		PL 259 Male	
BNC Barrel Female		SO 239 Barrel	
BNC Male		SO-239 Female	
BNC T		Type "N" Male	
Lightning Protection Type "N" Female		Type "N" Barrel	
Lightning Protecting Type "N" Female			

Courtesy of Dave Jordan /

* Corporate and product names are used for illustration, no endorsement is implied.

Appendix F Cable Properties

Attenuation (dB per 100 feet)					
MHz	1	30	150	500	1000
RG-174	.77	4.46	10.76	21.8	33.64
LMR-100A®	.70	3.91	8.9	16.68	24.12
RG-58	.36	2.12	5.10	10.30	15.86
LMR-200®	.32	1.76	3.98	7.33	10.47
RG-59	.29	1.66	3.85	7.36	10.84
RG-8X	.28	1.64	4.15	8.87	14.22
LMR-240®	.24	1.34	3.02	5.59	8.00
RG-8	.12	.68	1.58	3.02	4.47
9913	.02	.08	1.7	2.9	4.4
RG-213	.19	1.11	2.65	5.23	8.17
LMR-400®	.12	.66	1.52	2.84	4.10
BURY-FLEX™	.14	.78	1.77	3.30	4.76

Values indicated are *approximate* and for comparison purposes only.
 LMR® is a registered trademark of Times Microwave Systems.

Compiled by Tom Brown / N4TAB

Appendix G Coded Squelch Systems

G.1 Continuous Tone Coded Squelch System (CTCSS) Tones and Codes

CTCSS Sorted By PL Code			
PL	Frequency	PL	Frequency
1A	103.5	9Z	229.1
1B	107.2	M1	203.5
1Z	100.0	M2	210.7
2A	114.8	M3	218.1
2B	118.8	M4	225.7
2Z	110.9	M5	223.6
3A	127.3	M6	241.8
3B	131.8	M7	250.3
3Z	123.0	WA	74.4
4A	141.3	WB	79.7
4B	146.2	WZ	69.3
4Z	136.5	XA	71.9
5A	156.7	XB	77.0
5B	162.2	XZ	67.0
5Z	151.4	YA	85.4
6A	173.8	YB	88.5
6B	179.9	YZ	82.5
6Z	167.9	ZA	94.8
7A	192.8	ZB	97.4
7Z	186.2	ZZ	91.5
8Z	206.5		

CTCSS Sorted By Frequency			
Frequency	PL	Frequency	PL
67.0	XZ	136.5	4Z
69.3	WZ	141.3	4A
71.9	XA	146.2	4B
74.4	WA	151.4	5Z
77.0	XB	156.7	5A
79.7	WB	162.2	5B
82.5	YZ	167.9	6Z
85.4	YA	173.8	6A
88.5	YB	179.9	6B
91.5	ZZ	186.2	7Z
94.8	ZA	192.8	7A
97.4	ZB	203.5	M1
100.0	1Z	206.5	8Z
103.5	1A	210.7	M2
107.2	1B	218.1	M3
110.9	2Z	223.6	M5
114.8	2A	225.7	M4
118.8	2B	229.1	9Z
123.0	3Z	241.8	M6
127.3	3A	250.3	M7
131.8	3B		

CTCSS refers to subaudible tones which are used to access a repeater or open the squelch on a receiver. The term "PL Code" is a registered trademark of Motorola. These may be used when programming transmit and receive frequencies into a transceiver. CTCSS tones are used in order to minimize co-channel interference and/or to "mask" unwanted transmissions. A repeater configured to require a CTCSS tone will remain silent until it receives a transmission from a radio sending the correct CTCSS tone. Likewise, a radio configured with a CTCSS tone on the receive side will not open squelch unless the transmitting station sends the correct tone. Communications Plans (ICS Form 205) should list any required CTCSS tones. Use the tables below when searching for the complete CTCSS tone frequency, or to determine a CTCSS tone frequency when provided with a PL Code.

G.2 Digital Coded Squelch (DCS) Codes

DCS Codes							
Normal	Inverted	Nor.	Inv.	Nor.	Inv.	Nor.	Inv.
023	047	155	731	325	526	516	432
025	244	156	265	331	465	523	246
026	464	162	503	332	455	526	325
031	627	165	251	343	532	532	343
036	172	172	036	346	612	546	132
043	445	174	074	351	243	565	703
047	023	205	263	364	131	606	631
051	032	212	356	365	125	612	346
053	452	223	134	371	734	624	632
054	413	225	122	411	226	627	031
065	271	226	411	412	143	631	606
071	306	243	351	413	054	632	624
072	245	244	025	423	315	654	743
073	506	245	072	431	723	662	466
074	174	246	523	432	516	664	311
114	712	251	165	445	043	703	565
115	152	252	462	446	255	712	114
116	754	255	446	452	053	723	431
122	225	261	732	454	266	731	155
125	365	263	205	455	332	732	261
131	364	265	156	462	252	734	371
132	546	266	454	464	026	743	654
134	223	271	065	465	331	754	116
143	412	274	145	466	662		
145	274	306	071	503	162		
152	115	311	664	506	073		
032	051	315	423				

DCS codes are a newer form of coded squelch that was added to offer additional options beyond the CTCSS tones. Some older radios do not have the ability to utilize DCS codes. DCS codes function the same and are utilized in a similar manner to CTCSS tones. Communications Plans documented on an ICS Form 205 should list any required DCS codes needed when programming radios. Use the tables below when searching for valid DCS codes.

G.3 Network Access Codes (NAC)

P25 Digital Codes

NAC – Network Access Codes

\$293 default NAC

\$F7E receiver will unsquelch with any incoming NAC

\$F7F a repeater with this NAC will allow incoming signals to be repeated with the NAC intact

TGID – Talkgroup ID

\$0001 default

\$0000 no-one, talkgroup with no users – used for individual call

\$FFFF talkgroup which includes everyone

Unit ID

\$000000 no-one – never associated with a radio unit

\$000001-\$98767F for general use

\$989689-\$FFFFFFE for talkgroup use or other special purposes

\$FFFFFFF designates everyone – used when implementing a group call with a TGID3

NOTES:

Appendix H GMRS/FRS

H.1 General Mobile Radio Service (GMRS)

The General Mobile Radio Service (GMRS) is in the 462 - 467 MHz spectrum range, and is covered under Part 95 of Title 47 CFR. The most common use of GMRS spectrum is short-distance, two-way personal/family communications using small, portable hand-held devices that function similar to walkie-talkies.

Similar services include the Family Radio Service (FRS) and the Multi-Use Radio Service (MURS). Some GMRS channels are shared with FRS, however FRS is narrowband and GMRS is usually wideband, and therefore interoperability between the two may not be reliable.

H.1.1 Licensing

GMRS licensing requirements are contained in Part 95 of Title 47 CFR. An individual FCC license is required to operate on a General Mobile Radio Service (GMRS) system. Licenses are issued for a five-year term and can be renewed between 90 days prior to the expiration date and up to the actual expiration date of the license.

A GMRS system licensed to a non-individual prior to July 31, 1987 is also eligible for renewal, but the licensee may not make any major modification to the system.

You can apply for a GMRS license if you are 18 years or older and not a representative of a foreign government. If you receive a license, any family member, regardless of age, can operate GMRS stations and units within the licensed system.

You can find information about GMRS licenses in the Universal Licensing System (ULS). The ULS radio service code and description for GMRS is ZA – General Mobile Radio Service.

H.1.2 Channels

GMRS Repeater Outputs: (25 KHz)

- Inputs are + 5 MHz
- Simplex prohibited on repeater inputs
- If CTCSS is required, try 141.3
- * Nationwide traveler's assistance

Frequency
462.5500
462.5750
462.6000
462.6250
462.6500
462.6750 *
462.7000
462.7250

GMRS Interstitial Frequencies:

- Simplex, not more than 5 watts
- ** Shared with FRS

Frequency **
462.5625
462.5875
462.6125
462.6375
462.6625
462.6875
462.7125

FRS Frequencies:

- Channels 1-7 shared with GMRS

Channel	Frequency
1	462.5625
2	462.5875
3	462.6125
4	462.6375
5	462.6625
6	462.6875
7	462.7125
8	467.5625
9	467.5875
10	467.6125
11	467.6375
12	467.6625
13	467.6875
14	467.7125

NOTES:

Appendix Incident Command System (ICS)

I.1 Basic ICS Organization

I.1.1 ICS Organizational Chart

The ICS organizational chart is a graphic representation of the incident, including:

- Positions and functions activated
- Chain of command
- Reporting relationships
- Responsibilities delegated
- Information flow

By principle, NIMS is a framework for interoperability and compatibility. ICS is modular and scalable system suitable for incidents and events of all types and sizes. Common terminology, which covers organizational functions, resource descriptions, and incident facilities, is a central part of NIMS that is particularly important for good communications. Therefore, appropriate and consistent use of these terms and organizational elements is important when creating ICS organizations.

NOTES:

NOTES:

Lined area for taking notes, consisting of multiple horizontal lines.

I.1.2 Incident Command System – Basic Organization

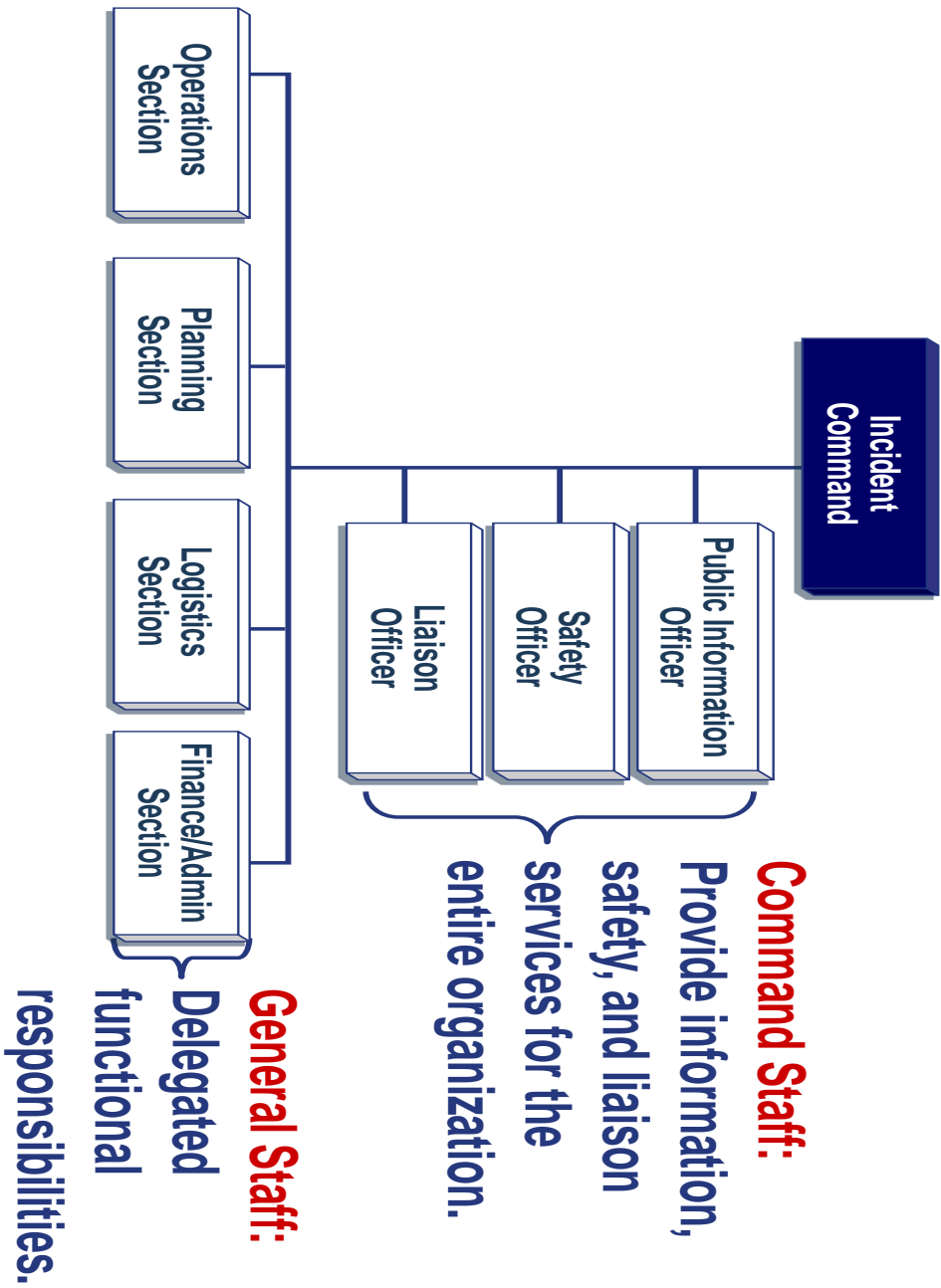

I.1.3 Expanded ICS Organization

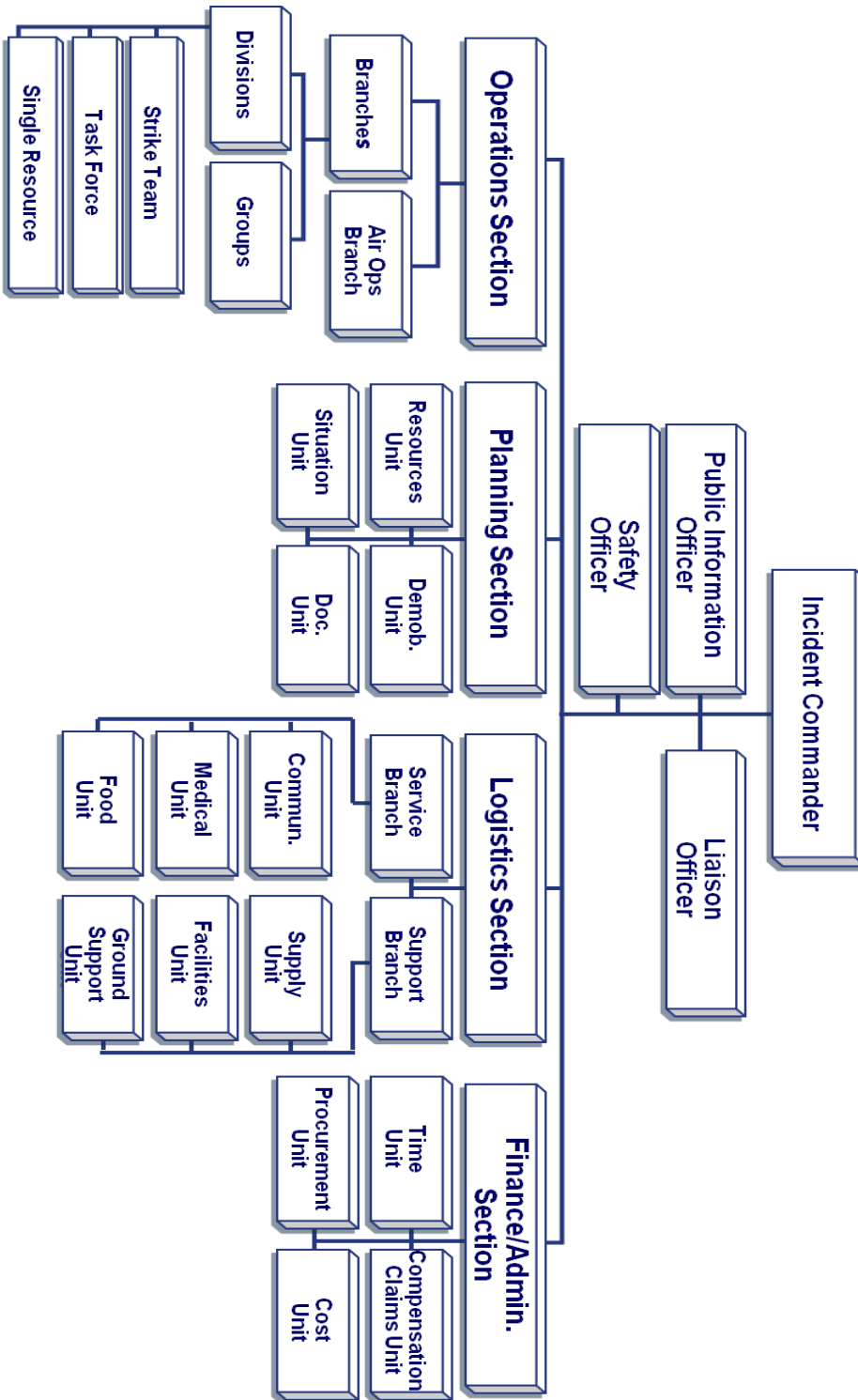

I.1.4 Logistics Section Communications Unit

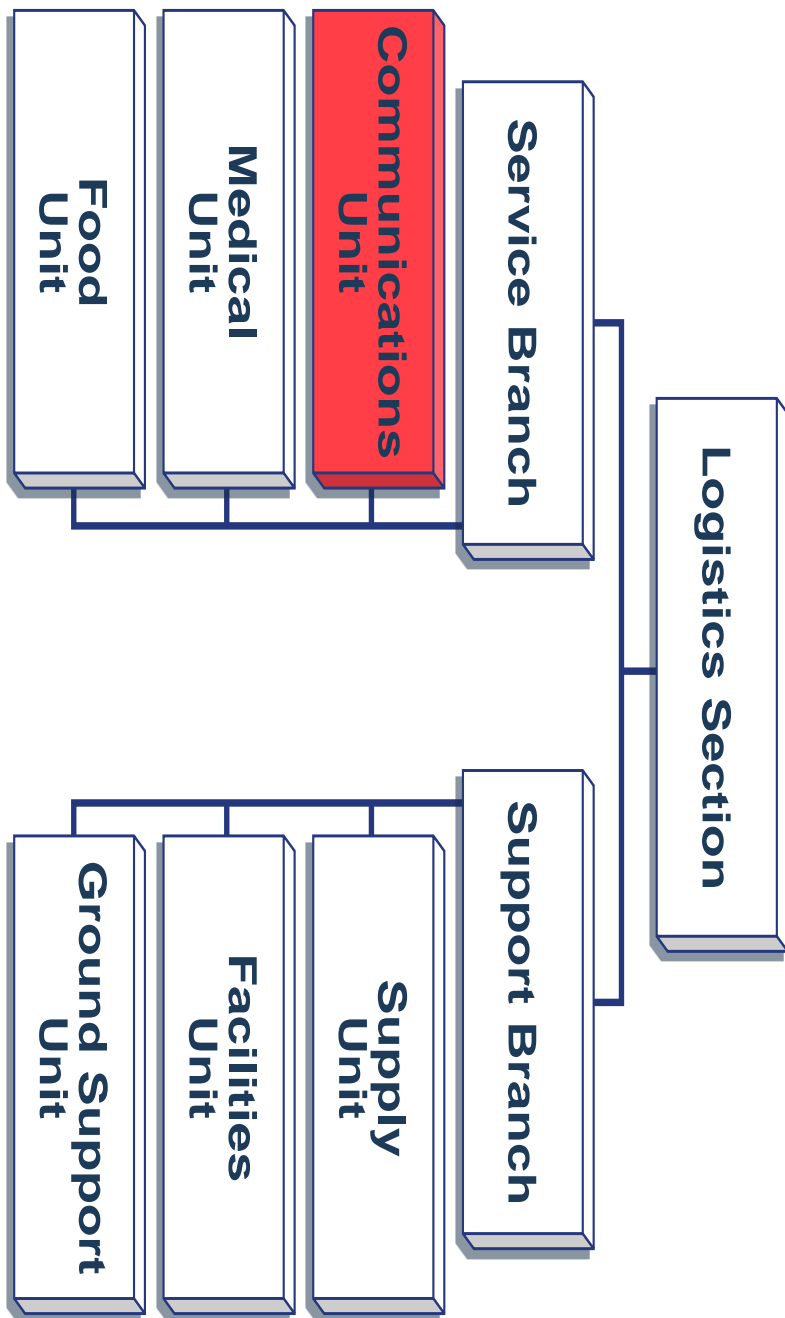

I.1.5 Communications Unit Organizational Structure

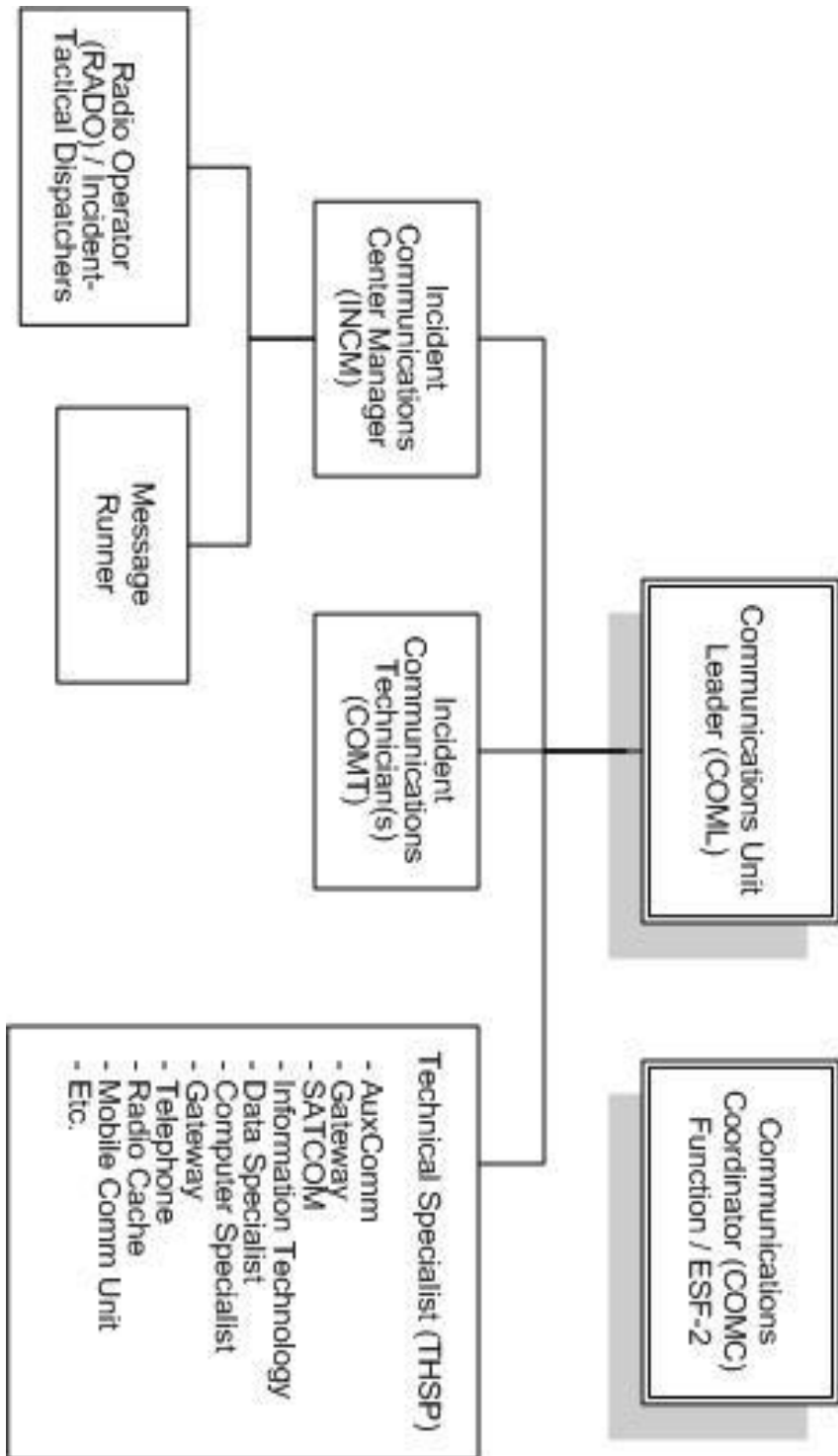

I.1.6 ICS Position Titles

Organizational Level	Title	Support Position
Incident Command	Incident Commander	Deputy
Command Staff	Officer	Assistant
General Staff (Section)	Chief	Deputy
Branch	Director	Deputy
Division/Group	Supervisor	N/A
Unit	Leader	Manager
Strike Team/Task Force	Leader	Single Resource Boss

I.2 Communications Unit Position Descriptions

I.2.1 Auxiliary Communications

Auxiliary Communications, or “AuxComm”, refers to organizations and personnel which provide various types of emergency communications support to emergency management, public safety, and other government agencies. AuxComm services are typically voluntary, and are commonly provided by amateur radio communicators, but may also include other volunteer organizations which have established relationships with the government organizations they support.

AuxComm services include emergency, backup, or supplemental communications support to government or non-government agencies during unexpected emergencies, planned events, or training exercises. AuxComm resources include a wide array of communications technology and personnel expertise which may be activated or deployed within the Communications Unit of the ICS organization. Auxiliary Communications personnel are considered Technical Specialists (THSPs) within the Communications Unit organizational structure.

I.2.2 Communications Unit Leader (COML)

1. Plans and manages the technical and operational functions of the Communications Unit during an incident or event
2. Supervises the Communications Unit. Manages Communications Unit personnel (INCM, RADO, COMT, THSP)
3. Participates in incident action planning.
4. Prepares the Incident Radio Communications Plan (ICS Form 205)

I.2.3 Incident Communications Center Manager (INCM)

1. Establishes and manages an Incident Communications Center (ICC)
2. Supervises RADO positions
3. Assists the COML

I.2.4 Radio Operator (RADO)

1. Staff positions in the ICC
2. Responsible for documenting radio and telephone messages
3. Incident Dispatchers, Tactical Dispatchers, and Telecommunicator Emergency Response Taskforce (TERT) team members may be assigned to RADO positions by a COML
4. RADOs, Incident Dispatchers, Tactical Dispatchers, and TERT team members typically receive specialized training to operate in an incident-based environment

I.2.5 Incident Communications Technician (COMT)

1. Responsible for supporting the technical functions of the Communications Unit
2. Install, test, troubleshoot communications systems
3. Identify requirements for radio system coverage
4. Support battery needs
5. Resolve interference issues
6. Program radios
7. Maintain/repair equipment

I.2.6 Technical Specialist (THSP)

- 1. Possesses expertise in specific types of communications technology (e.g., audio gateways, radio caches, telephone, data, mobile communications assets, auxiliary communications)
- 2. Possess a particular skill or qualification involving communications technology, e.g., geographic information systems (GIS), Amateur Radio, information technology (IT), radio programming

I.3 External Support to the Communications Unit

I.3.1 Communications Coordinator (COMC)

- 1. The COMC is not technically part of the Communications Unit, but serves as an interface to COMLs in the field
- 2. Provides support to the Communications Unit and COML
- 3. Responsibilities frequently performed by ESF #2 representative in an EOC, or a Public Safety Communications Center supervisor. May operate at the local, regional, state, or federal levels
- 4. Performs frequency coordination responsibilities within a region or a state during an incident or event
- 5. Reviews Incident Radio Communications Plans to ensure communications channels / talkgroups are allocated and used effectively. Works with the COML to assign channel/talkgroup resources in support of the Incident Radio Communications Plan
- 6. Coordinates among multiple incident sites, dispatch centers, incident command personnel, etc., to prevent or resolve interference issues

NOTES:

I.4 ICS Roles and Responsibilities

Incident Command - sets the incident objectives, strategies, and priorities, and has overall responsibility at the incident or event.

Command Staff Positions - assigned to carry out staff functions needed to support the Incident Commander.

Public Information Officer - the conduit for information to internal and external stakeholders, including the media.

Safety Officer - monitors safety conditions and develops measures for assuring the safety of all assigned personnel.

Liaison Officer - the primary contact for supporting organizations that are assisting at an incident, but are not participating within the ICS structure.

General Staff Positions - responsible for the functional aspects of the incident command structure.

Operations - conducts tactical operations to carry out the plan. Develops the defined objectives and organization, and directs all tactical resources.

Planning - prepares and documents the Incident Action Plan to accomplish the objectives, collects and evaluates information, maintains resource status, and maintains documentation for incident records.

Logistics - provides support, resources, and all other services needed to meet the operational objectives.

Finance/Administration - monitors costs related to the incident. Provides accounting, procurement, time recording, and cost analyses.

Section - the organizational level having functional responsibility for primary segments of incident management (Operations, Planning, Logistics, Finance/Administration). The Section level is organizationally between Branch and Incident Commander.

Branch - the organizational level having functional, geographical, or jurisdictional responsibility for major parts of the incident operations. The Branch level is organizationally between Section and Division/Group in the Operations Section, and between Section and Units in the Logistics Section. Branches are identified by the use of Roman Numerals, by function, or by jurisdiction name.

Division - the organizational level having responsibility for operations within a defined geographic area. The Division level is organizationally between Branches and Strike Teams.

Group - groups are established to divide the incident into functional areas of operation. Groups are located between Branches and Resources.

Unit - the organizational element having functional responsibility for a specific incident planning, logistics, or finance/administration activity.

Task Force - a group of resources with common communications and a leader that may be pre-established and sent to an incident, or formed at an incident.

Strike Team - specified combinations of the same kind and type of resources, with common communications and a leader.

I.5 ICS Forms

The ICS uses a series of standard forms and supporting documents that convey directions for the accomplishment of the objectives and distributing information. Listed below are the standard ICS form titles and descriptions of each form:

Standard Form Title	Description
Incident Briefing ICS 201	Provides the Incident Command/Unified Command and General Staffs with basic information regarding the incident situation and the resources allocated to the incident. This form also serves as a permanent record of the initial response to the incident.
Incident Objectives ICS 202	Describes the basic strategy and objectives for use during each operational period.
Organization Assignment List ICS 203	Provides information on the response organization and personnel staffing.
Assignment List ICS 204	Used to inform personnel of assignments. After Incident Command/Unified Command approve the objectives, staff members receive the assignment information contained in this form.
Incident Radio Communications Plan ICS 205	Provides, in one location, information on the assignments for all communications equipment for each operational period. The plan is a summary of information. Information from the Incident Communications Plan on frequency assignments can be placed on the appropriate Assignment form (ICS Form 204).
Incident Radio Communications Plan ICS 205A	The Communications List (ICS 205A) records methods of contact for incident personnel. While the Incident Radio Communications Plan (ICS 205) is used to provide information on all radio frequencies down to the Division/Group level, the ICS 205A indicates all methods of contact for personnel assigned to the incident (radio frequencies, phone numbers, pager numbers, etc.), and functions as an incident directory.
Medical Plan ICS 206	Provides information on incident medical aid stations, transportation services, hospitals, and medical emergency procedures.
Incident Status Summary ICS 209	Summarizes incident information for staff members and external parties, and provides information to the Public Information Officer for preparation of media releases.
Incident Check-In List ICS 211	Used to check in personnel and equipment arriving at or departing from the incident. Check-in/out consists of reporting specific information that is recorded on the form.
General Message ICS 213	<p>Used by:</p> <ul style="list-style-type: none"> • Incident dispatchers to record incoming messages that cannot be orally transmitted to the intended recipients. • EOC and other incident personnel to transmit messages via radio or telephone to the addressee. • Incident personnel to send any message or notification that requires hard-copy delivery to other incident personnel.
Activity Log ICS 214	Provides a record of unit activities. Unit Logs can provide a basic reference from which to extract information for inclusion in any after-action report.

Standard Form Title	Description
Operational Planning Worksheet ICS 215	Documents decisions made concerning resource needs for the next operational period. The Planning Section uses this Worksheet to complete Assignment Lists, and the Logistics Section uses it for ordering resources for the incident. This form may be used as a source document for updating resource information on other ICS forms such as the ICS 209.
Incident Action Plan Safety Analysis ICS 215A	Communicates to the Operations and Planning Section Chiefs safety and health issues identified by the Safety Officer.
Communications Resource Availability Worksheet 217A	This worksheet is prepared prior to an incident with complete details of available channels/talkgroups in a given area. This document should include all public safety frequencies/talkgroups available (with established use agreements), regardless of agency, discipline or ownership, with the understanding that authorization may be required to use them.
Air Operations Summary ICS 220	Provides information on air operations including the number, type, location, and specific assignments of helicopters and fixed-wing aircraft.
General Plan ICS 226	Addresses long-term objectives approved by Incident Command/ Unified Command. These objectives are often expressed as milestones (i.e., timeframes for the completion of all and/or portions of incident response operations). A General Plan should identify the major tasks to be carried out through to the end of emergency response operations, the duration of the tasks, and the major equipment and personnel resources needed to accomplish the tasks within the specified duration.
ICS 309	The Communications Log may be used to record telephone or radio traffic when other means are not available. It may serve as the only record of communication or tactical actions.

NOTES:

INCIDENT RADIO COMMUNICATIONS PLAN (ICS 205)

1. Incident Name: _____ **2. Date/Time Prepared:** Date: _____ Time: _____ **3. Operational Period:** Date From: _____ Time From: _____ Date To: _____ Time To: _____

4. Basic Radio Channel Use:										
Zone Gp. #	Ch #	Function	Channel Name/Trunked Radio System Talkgroup	Assignment	RX Freq N or W	RX Tone/NAC	TX Freq N or W	TX Tone/NAC	Mode (A, D, or M)	Remarks



5. Special Instructions: _____

6. Prepared by (Communications Unit Leader): Name: _____ Signature:  _____

ICS 205 IAP Page _____ Date/Time: _____

I.5.3 ICS Form 213

GENERAL MESSAGE (ICS 213)

1. Incident Name (Optional):		
2. To (Name and Position):		
3. From (Name and Position):		
4. Subject:	5. Date:	6. Time
7. Message:		
8. Approved by: Name: _____ Signature:  Position/Title: _____		
9. Reply:		
10. Replied by: Name: _____ Position/Title: _____ Signature: 		
ICS 213	Date/Time: _____	

I.5.4 ICS Form 214

ACTIVITY LOG (ICS 214)

1. Incident Name:		2. Operational Period: Date From: _____ Date To: _____	
		Time From: _____	Time To: _____
3. Name:		4. ICS Position:	5. Home Agency (and Unit):
6. Resources Assigned:			
Name ICS Position Home Agency (and Unit)			
7. Activity Log:			
Date/Time	Notable Activities		
8. Prepared by: Name: _____ Position/Title: _____ Signature: _____			
ICS 214, Page 1		Date/Time: _____	

I.5.5 ICS Form 217A

COMMUNICATIONS RESOURCE AVAILABILITY WORKSHEET								Frequency Band		Description	
ICS 217A											
Channel Configuration	Channel Name / Trunked Radio System Talk Group	Eligible Users	RX Freq N / W	RX Tone / NAC	TX Freq N / W	TX Tone / NAC	Mode A, D, or M	Notes			

The convention calls for frequency lists to show four digits after the decimal place, followed by either an "N" or a "W", depending on whether the frequency is narrow or wide band. Mode refers to either "A" or "D" indicating analog or digital (e.g. Project 25) or "M" indicating mixed mode. All channels are shown as if programmed in a control station, mobile or portable radio. Repeater and base stations must be programmed with the Rx and Tx reversed.

Appendix J Standard Phonetic Alphabet and its Equivalents

Character	International Phonetic	Morse Code
A	Alpha	• —
B	Bravo	— • • •
C	Charlie	— • — •
D	Delta	— • •
E	Echo	•
F	Foxtrot	• • — •
G	Golf	— — •
H	Hotel	• • • •
I	India	• •
J	Juliet	• — — —
K	Kilo	— • —
L	Lima	• — • •
M	Mike	— —
N	November	— •
O	Oscar	— — —
P	Papa	• — — •
Q	Quebec	— — • —
R	Romeo	• — •
S	Sierra	• • •
T	Tango	—
U	Uniform	• • —
V	Victor	• • • —
W	Whiskey	• — —
X	X-ray	— • • —
Y	Yankee	— • — —
Z	Zulu	— — • •

Appendix K AUXFOG URL/Website Listing

American Radio Relay League (ARRL): www.arrl.org

APCO International: www.apcointl.org

CASM: publicsafetytools.info

Civil Air Patrol: www.gocivilairpatrol.com

COML-COMT Yahoo Group: groups.yahoo.com/group/OEC-COML

DHS OEC: www.dhs.gov/xabout/structure/gc_1189774174005.shtm

EMAC: www.emacweb.org

FCC Enforcement Bureau: www.fcc.gov/eb

FCC Public Safety & Homeland Security Bureau: www.fcc.gov/pshs

FCC Special Temporary Authority (STA): www.fcc.gov/pshs/services/sta.html

FCC ULS: wireless.fcc.gov/uls

FEMA: www.fema.gov

FEMA Acronyms, Abbreviations, and Terms: www.fema.gov/fema-acronyms-abbreviations-and-terms

FEMA Resource Typing: www.fema.gov/pdf/emergency/nims/incident_mgmt.pdf

FEMA Training and Education: training.fema.gov

First Responder Communities of Practice: <https://communities.firstresponder.gov>

Geographic Area Coordination Centers: gacc.nifc.gov/

Government Emergency Telecommunications Service (GETS): dhs.gov/government-emergency-telecommunications-service-gets

Government Printing Office: www.gpo.gov

ICS Interactive Forms: www.fema.gov/pdf/emergency/nims/ics_forms_2010.pdf

International Telecommunication Union (ITU): www.itu.int

Lessons Learned Information Sharing: www.llis.gov

National Emergency Number Association: www.nena.org

National Geographic Area Coordination Center: gacc.nifc.gov

National Institute of Standards and Technology (NIST): www.nist.gov

National Interagency Fire Center (NIFC): www.nifc.gov

National Interagency Incident Communications: www.nifc.gov/NIICD (case sensitive)

National Interoperability Information Exchange (NIIX): www.niix.org

National Oceanic and Atmospheric Administration (NOAA): www.noaa.gov

National Public Safety Telecommunications Council: www.npstc.org

National Regional Planning Council (NRPC) www.nrpc.us

National Telecommunications & Information Admin (NTIA): www.ntia.doc.gov

National Weather Service: weather.gov

National Wildfire Coordinating Group (NWCG): www.nwcg.gov

Naval Oceanography Weather Portal: www.usno.navy.mil

NIMS Information: www.fema.gov/emergency/nims

NPSTC: www.npstc.org

NTIA Manual of Regulations and Procedures for Federal Radio Frequency Management: www.ntia.doc.gov/page/2011/manual-regulations-and-procedures-federal-radio-frequency-management-redbook

OEC Public Safety Technical Assistance Tools: publicsafetytools.info

Radio Reference: www.radioreference.com

Red Cross Safe and Well: www.redcross.org/safeandwell

SAFECOM: www.safecomprogram.gov

Telecommunicator Emergency Response Taskforce: www.njti-tert.org

Title 47 Code of Federal Regulations: http://www.ecfr.gov/cgi-bin/text-idx?c=ecfr&tpl=/ecfrbrowse/Title47/47tab_02.tpl

USGS: www.usgs.gov

USGS Topo Maps: topomaps.usgs.gov

Weather Underground: www.wunderground.com

Wireless Priority Service (WPS): www.dhs.gov/wps

Appendix L Glossary and Terms

ACS	Auxiliary Communications Service
ARES	Amateur Radio Emergency Service
ARRL	American Radio Relay League
ATM	Automated Teller Machine
AUXCOMM	Auxiliary Communications
AUXFOG	Auxiliary Field Operations Guide
AWG	American Wire Gauge
CB	Citizens Band
CERT	Community Emergency Response Team
CFR	Code of Federal Regulations
COML	Communications Unit Leader
COMT	Incident Communications Technician
CTCSS	Continuous Tone-Coded Squelch System
DC	Direct Current
DCS	Digital Coded Squelch
DHS	Department of Homeland Security
EMA	Emergency Management Agency
EMCOMM	Emergency Communications
EOC	Emergency Operations Center
ETA	Estimated Time of Arrival
FCC	Federal Communications Commission
FOG	Field Operations Guide
FRS	Family Radio Service
GETS	Government Emergency Telecommunications Service
GIS	Geographic Information System
GMRS	General Mobile Radio Service
GPS	Global Positioning System
HAZMAT	Hazardous Materials
HF	High Frequency
IARU	International Amateur Radio Union
ICS	Incident Command System

INCM	Incident Communications Center Manager
MURS	Multi-Use Radio Service
NAC	Network Access Code
NIFOG	National Interoperability Field Operations Guide
NIMS	National Incident Management System
NIST	National Institute of Standards and Technology
NOAA	National Oceanic and Atmospheric Administration
NTIA	National Telecommunications and Information Administration
NWS	National Weather Services
OEC	Office of Emergency Communications
OEM	Office of Emergency Management
OES	Office of Emergency Services
PSTN	Public Switched Telephone Network
RACES	Radio Amateur Civil Emergency Service
SCIP	Statewide Communications Interoperability Plan
RADO	Radio Operator
RF	Radio Frequency
SAR	Search and Rescue
SEOC	State EOC
SWR	Standing Wave Ratio
TERT	Telecommunicator Emergency Response Taskforce
THSP	Technical Specialist
TICP	Tactical Interoperable Communications Plan
UHF	Ultra high frequency
ULS	Universal Licensing System
VHF	Very high frequency
VOM	Volt-Ohm Milliammeter
WPS	Wireless Priority Service

NOTES:

NOTES

Credits

John E. Peterson*
DHS/OEC/ICTAP
Telecommunications Specialist

Tom Brown / N4TAB
North Carolina AuxComm Coordinator
North Carolina Communications Leader (COML)

Ken Carpenter*
DHS/OEC/ICTAP
Telecommunications Specialist

Lee H. Cooper / W5LHC
Senior IT Project Manager
Texas Department of State Health Services

Mike Corey / K11U
Emergency Preparedness Manager
American Radio Relay League

Sandra K. Dooley
DHS/OEC/ICTAP
Functional Area IPT Lead for COMU

David Jordan / WA3GIN
CISO / OEM ESF # 2 Lead
Arlington County Government (Virginia)

Randy Kerr*
DHS/OEC/ICTAP
AuxComm, COML, COMT Instructor

Hank Koebler, Jr.*
DHS/OEC/ICTAP
AuxComm Instructor

Ross Merlin*
DHS/OEC/ICTAP
Senior Telecommunications Specialist

* Licensed Amateur Radio Operators with a
General Class license or higher.



Homeland Security

